

# *Digital Video Camera Module*

---

## Technical Manual



**XCL-C30/C32/C130/C280/C500  
XCL-C30C/C32C/C130C/C280C/  
C500C**

---

# Table of Contents

---

## Overview

Features .....	3
Typical CCD Phenomena .....	4
System Components .....	5
Connection .....	6
Location and Function of Parts and Operation .....	7
Front/Top/Bottom .....	7
Using a tripod .....	7
Rear .....	8
Connecting the cables .....	9

---

## Connections

Communication Setting .....	10
Camera Link Tap .....	10
Data Order .....	11
1tap .....	11
2tap .....	11
Port assignment .....	12
Color pixel array .....	12
Trigger Signal Input .....	13
Trigger signal polarity .....	13
GPIO Connector .....	14

---

## Functions

Partial Scan .....	15
Binning .....	15
Sensor Tap .....	15
Switching sensor tap .....	15
Level correction between sensor taps .....	16
Adjusting level correction between sensor taps .....	16
Output Bit Depth .....	16
Gain .....	16
Analog gain .....	16
Digital gain .....	16
Auto gain (AGC) .....	16
Shutter (Exposure) .....	17
Configuring the setting .....	17
Auto exposure (AE) .....	17
Combination of Continuous AGC and Continuous AE .....	17
Trigger Control .....	18
Free run/trigger mode .....	18
Special trigger .....	19
Trigger source .....	20
Trigger inhibition .....	20
Trigger shift .....	21
Trigger delay .....	22
Trigger counter .....	22
Frame counter .....	22

Trigger range limit .....	22
Trigger control .....	23
Frame Rate .....	23
Auto frame rate .....	23
Specifying frame rate .....	24
Displaying frame rate .....	24
Fastest frame rate for partial scanning .....	25
Timing Chart .....	28
Horizontal timing .....	28
Vertical timing .....	28
Trigger latency .....	29
Sensor Readout (Sensor Output) .....	31
White Balance .....	32
LUT .....	32
Binarization .....	32
5-point interpolation .....	32
Arbitrary setting .....	33
Save LUT .....	33
Color Matrix Conversion .....	33
Test Chart Output .....	33
GPIO .....	33
GPI .....	33
GPO .....	34
Pulse Train Generator .....	36
Status LED .....	36
Temperature Readout Function .....	36
Defect Correction .....	36
Shading Correction .....	37
Sensitivity Control .....	38
User Set .....	38
User set name .....	38
User set memory .....	38
Free Memory .....	39
User ID .....	39
Saving and Startup .....	39
Initializing .....	39
Camera Information .....	39
Help Command .....	39
Restart .....	39

---

## Camera Control Commands

Command Form .....	40
Command Input and Response .....	40
Command List .....	41
Parameter List .....	47

---

## Specifications

Specifications .....	48
Spectral Sensitivity Characteristics (Typical Values) .....	49
Dimensions .....	51

## Overview

This unit is a digital video camera module that outputs digital images utilizing LVDS via the DIGITAL IF connector.

## Features

### DIGITAL IF connector

Equipped with a Camera Link standard mini connector. The unit can output a detailed and high speed digital image.

### High image quality

The following models and their CCDs are shown below.

Model name	CCD
<b>XCL-C30/C30C</b>	1/3 type 330,000-pixel PS CCD (Monochrome/Color)
<b>XCL-C32/C32C</b>	1/2 type 330,000-pixel PS CCD (Monochrome/Color)
<b>XCL-C130/C130C</b>	1/3 type 1,250,000-pixel PS CCD (Monochrome/Color)
<b>XCL-C280/C280C</b>	1/1.8 type 2,830,000-pixel PS CCD (Monochrome/Color)
<b>XCL-C500/C500C</b>	2/3 type 5,050,000-pixel PS CCD (Monochrome/Color)

### Various settings

Sending a command from the host device allows various settings, including the following.

- Gain
- Shutter
- Partial scan
- Trigger control
- LUT (Look Up Table)
- Output: 8/10/12-bit or RGB 24-bit
- Defect correction
- Shading correction

### Electronic shutter function

Set anywhere from 1/100,000 sec to 2 sec in 1  $\mu$ s increments.

### External trigger shutter function

By synchronizing with an external trigger signal, any shutter timing can be used.

### Partial scan

The camera module can limit the number of video output lines to achieve high frame rates, enabling high-speed image processing.

### Body fixing

The screw holes to install the camera module are located under the front panel (the CCD reference plane). Installing the camera module on the front panel minimizes deviation of the optical axis.

### LUT (Look Up Table)

You can switch to OFF or ON. When set to OFF, you can select from five preset values, such as inversion, binarization, any of five-point approximation, etc.

### Switching an Output Bit Length

You can select 8-bit output, 10-bit output, or 12-bit output. For color models, you can also select an RGB 24-bit output.

### Binning (Monochrome camera only)

Sensitivity can be doubled by combining two pixels aligned vertically, you can achieve a standard output frame rate between 1.8x and 2x. Sensitivity can be doubled by combining two pixels align horizontally. You can set horizontal and vertical binning at the same time.

### Defect correction

The unit includes a function to reduce sensor defects, and can be set to ON or OFF.

### Shading correction

The unit includes a function to correct shading, resulting from a light source or a particular lens, and can be set to ON or OFF.

#### Note

The CCD is driven at high speed during a Partial scan or Binning operation. In this situation, if intense light is input to the camera, the peripheral areas of the video image may be affected. In such a situation, adjust the amount of light using the iris.

# Typical CCD Phenomena

The following effects on the monitor screen are characteristic of CCD cameras. They do not indicate any fault with the camera module.

## Smear

This occurs when shooting a very bright object such as electric lighting, the sun, or a strong reflection.

This phenomenon is caused by an electric charge induced by infrared radiation deep in the photosensor. It appears as a vertical smear, since the CCD imaging element uses an interline transfer system.

## Vertical aliasing

When you shoot vertical stripes or lines, they may appear jagged.

## Blemishes

A CCD image sensor consists of an array of individual sensor elements (pixels). A malfunctioning sensor element will cause a single pixel blemish in the picture (This is generally not a problem.).

## White speckles

While CCD image pickup device is made by an accurate technique, imperceptible speckles may rarely come up on the screen due to cosmic rays and so on. This is connected to the principle of CCD image pickup device, not a malfunction. And the white speckles are easy to come up in the following conditions.

- Using the camera in high temperature
- When turning up the gain

### Note

If strong light enters a wide area of the screen, the screen may become dark. This is not a malfunction.

If this occurs, avoid strong light or adjust the lens iris to reduce the light amount.

## CCD used in XCL-C130/C130C

Under the following operating conditions, because the construction of the CCD of this camera is different from the CCDs used in other cameras, the brightness level near the pedestal may increase, or white dots described above may become pronounced, degrading the image quality.

- When used in a hot environment
- When the gain is increased
- When the exposure time is long (0.1 second or longer)

In these situations, decrease the environmental temperature, or adjust the light source or lens aperture, and change the camera gain or exposure time.

### Note on laser beams

Laser beams may damage a CCD. You are cautioned that the surface of a CCD should not be exposed to laser beam radiation in an environment where a laser beam device is used.

# System Components

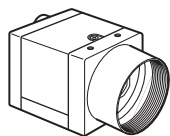

Video Camera Module

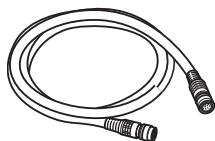

Camera cable  
 CCXC-12P02N (2 m, 6.6 ft)  
 CCXC-12P05N (5 m, 16.4 ft)  
 CCXC-12P10N (10 m, 32.8 ft)  
 CCXC-12P25N (25 m, 82 ft)

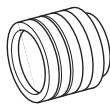

C-mount lens  
 Use a lens appropriate for the pixel count of the camera.

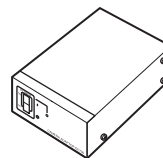

Camera adaptor  
 DC-700/700CE

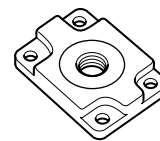

Tripod adaptor  
 VCT-333I (Insulated type)

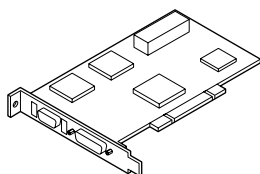

Camera module interface board

Install the board in a PCI bus slot in devices such as a computer. Select a commercially available interface board compatible with the Camera Link feature. You can use either a board that supports PoCL, or one that does not.

Due to the performance of the board, the frame rate may become low according to lack of processing capacity. To have this product output frames at the highest speed, use a board corresponding to PCI-Express.

Performance may also be dependent on the host device (e.g., Computer), so consult the dealer if images are not displayed properly.

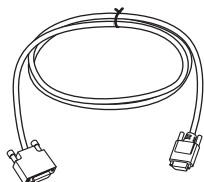

Camera Link cable  
 (Sony Camera-compatible)

This cable connects to the DIGITAL IF connector on the rear panel of the camera module. Image/control signals are transmitted via this cable.

If there is support for PoCL, power is also supplied at the same time.

If you use a camera module interface board with support for PoCL, be sure to use a camera link cable with support for PoCL. Select a proper cable as the maximum usable length of a cable differs due to the attribute of each cable.

Spotted noise may appear in a specific brightness in the window according to the attribute of the cable. If this noise is an obstacle, shorten the cable.

# Connection

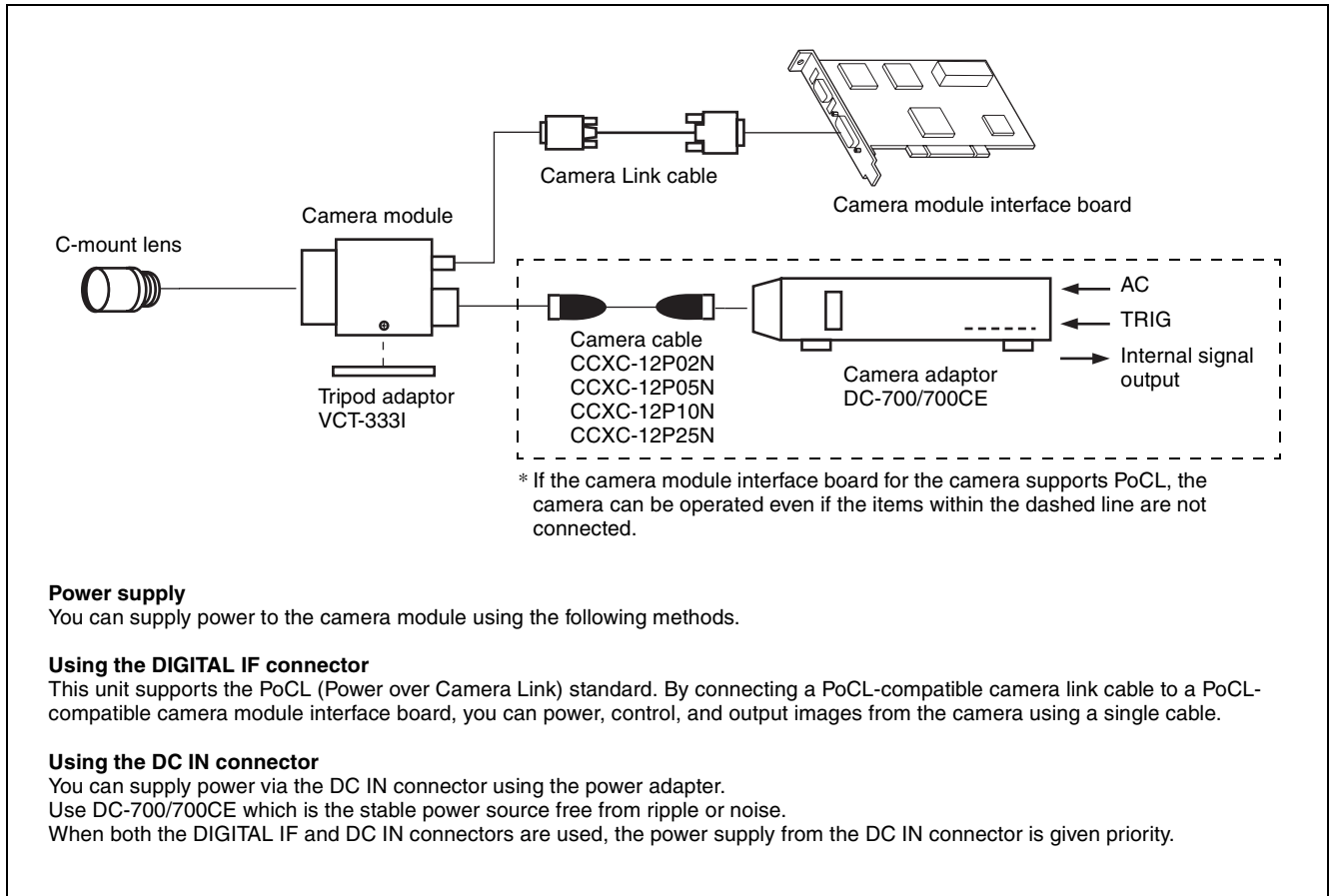

# Location and Function of Parts and Operation

## Front/Top/Bottom

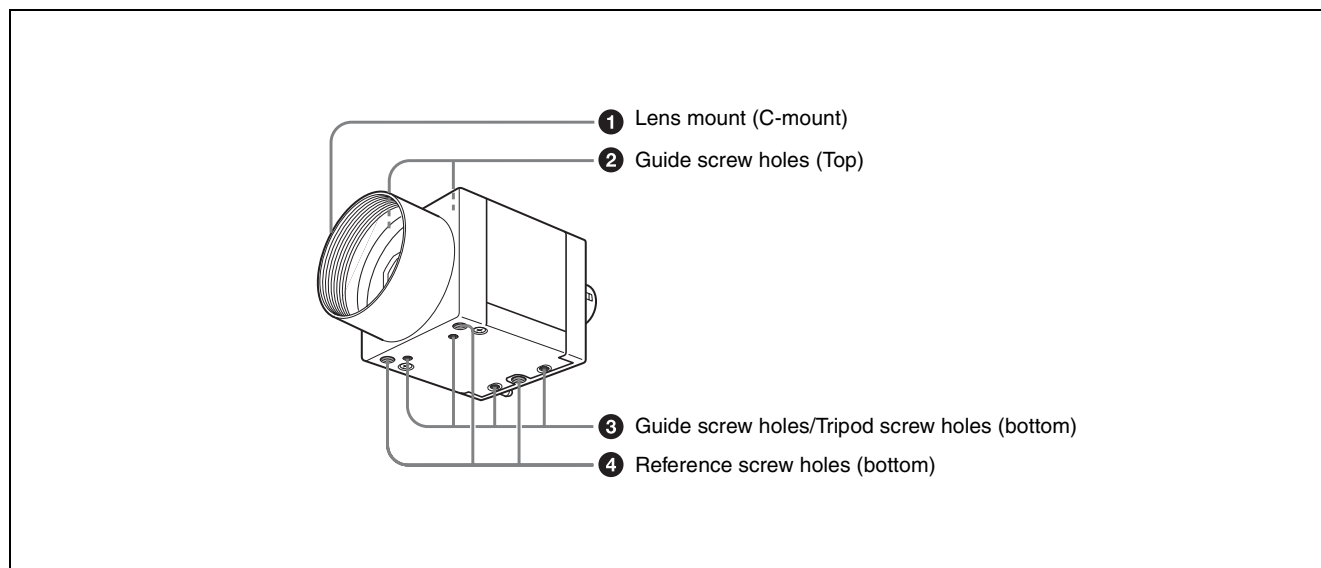

### 1 Lens mount (C-mount)

Attach any C-mount lens or other optical equipment.

#### Note

The lens must not project more than 10 mm (13/32 inch) from the lens mount.

When you use the camera with the lens attached, the resolution of the image output from the camera may differ according to the performance of the lens. Note it when you select a lens.

The performance of a lens may change according to the aperture level.

If the resolution is not enough, adjust the aperture level.

### 2 Guide screw holes (Top)

### 3 Guide screw holes/Tripod screw holes (bottom)

When using a tripod, use these four screw holes to attach a VCT-333I tripod adaptor.

### 4 Reference screw holes (bottom)

These precision screw holes are for locking the camera module. Locking the camera module into these holes secures the optical axis alignment.

#### Note

Refer to XCL-U100 Dimensions in page 51 for about the position/size of the Guide hole and the Reference hole.

## Using a tripod

To use the tripod, install the tripod adaptor VCT-333I (not supplied) on the camera module.

Use a tripod screw with a protrusion ( $\ell$ ) extending from the installation surface, as follows, and tighten it, using a screwdriver. Be sure that the protrusion ( $\ell$ ) does not exceed 5.5 mm (0.2 in.) in length.

Length 4.5 to 5.5 mm

Length 0.18 to 0.22 inches



#### Note

If you install a tripod adaptor (not supplied), use the screws provided.

## Rear

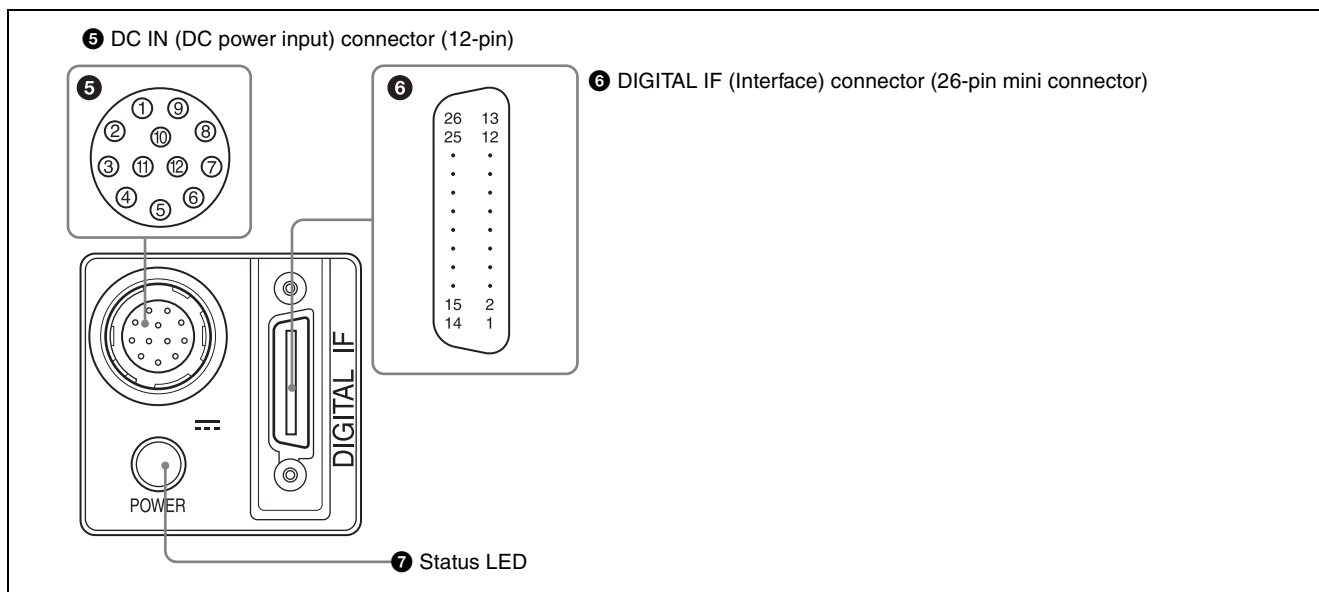

### 5 DC IN (DC power input) connector (12-pin)

You can connect a camera cable CCXC-12P05N etc. to input the 12 V DC power supply. The pin configuration of this connector is as follows. You can operate the camera without using this connector when using a PoCL-compatible camera module interface board. For details on the pin arrangement, see the following table.

Pin No.	Signal	Pin.No.	Signal
1	Ground	7	GPI3 <sup>*2</sup>
2	DC 12 V	8	Ground
3	Ground	9	GPO3 <sup>*1</sup>
4	GPO1 <sup>*1</sup>	10	GPI2 <sup>*2</sup>
5	Ground	11	GPI1 <sup>*2</sup>
6	GPO2 <sup>*1</sup>	12	Ground

#### \*1 Signal output from pin 4, 6, 9 (GPO1/2/3) of DC IN connector

This setting allows you to select from exposure signal, strobe control signal, Hi/Low fixed value, etc. The initial values of GPO1/2/3 are all Hi fixed.

#### \*2 Signal output from pin 7, 10, 11 (GPI3/2/1) of DC IN connector

Function as GPI input or trigger input. The initial setting is GPI1 for trigger input and GPI2/3 for GPI input.

### 6 DIGITAL IF (Interface) connector (26-pin mini connector)

#### Camera Link Base Configuration:

You can connect a Camera Link cable to this connector to control a camera module from a host device utilizing the serial communication protocol while outputting a video signal from the camera module. If you use a camera module interface board with support for PoCL, you can also supply power from this connector. You can input the external trigger signal via the DIGITAL IF

connector and operate a camera module in the external trigger mode.

The following table shows the relation between the pin numbers of the DIGITAL IF connector and the input/output signals and the like.

Pin No.	Signal	Pin No.	Signal
1	Power supply or Ground*	14	Ground
2	X0-	15	X0+
3	X1-	16	X1+
4	X2-	17	X2+
5	XCLK-	18	XCLK+
6	X3-	19	X3+
7	SerTC+	20	SerTC-
8	SerTFG-	21	SerTFG+
9	CC1-	22	CC1+
10	CC2+	23	CC2-
11	CC3-	24	CC3+
12	CC4+	25	CC4-
13	Ground	26	Power supply or Ground*

#### \* About the 1st pin and 26th pin of the DIGITAL IF connector

The connection differs depending on the type of camera module interface board you use.

In the case of PoCL support:

Both the 1st pin and 26th pin are Power supply

In the case of non-PoCL support:

Both the 1st pin and 26th pin are Ground

### 7 Status LED (Green)

When power is supplied to the camera, this button is lit. Various settings are available, such as to light up when interlocking with the trigger signal (page 36).



## Connecting the cables

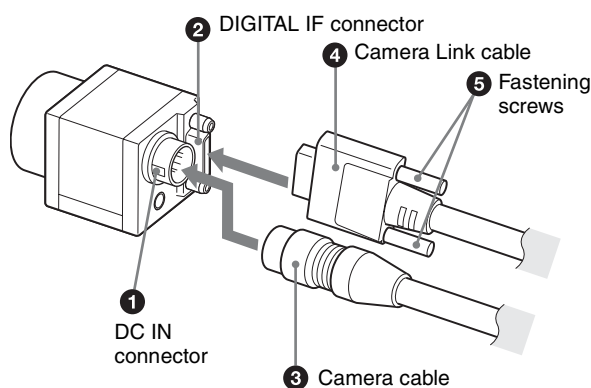

Connect the camera cable to the DC IN connector and the Camera Link cable to the DIGITAL IF cable respectively. If you use a camera module interface board with support for PoCL, you can operate the camera even if you do not connect the camera cable to the DC IN connector. When you connect the Camera Link cable, turn the two fastening screws on the connector to secure the cable tightly.

Connect the other end of the camera cable to the DC-700/700CE and the other end of the Camera Link cable to the camera module interface board.

### Note

When using the camera with a PoCL connection, make sure you connect a PoCL compatible cable. Connecting a cable that is not compatible with PoCL (non-PoCL) may cause a malfunction of the camera or camera module interface board.

## Controlling the camera from the host device

You can control the camera from host device such as a computer. The following table shows the major control functions.

You can send a command corresponding to the control items, with parameters for the desired settings, if necessary, from the host device to control the camera. Refer to “Camera Control Commands” on page 40 for details on how to send a command, the commands, and their parameters.

Control functions	Description	
Operating mode	Free run/Trigger	
Shutter speed	Free run	1/100,000 sec to 2 sec
	Trigger edge detection	1/100,000 sec to 2 sec
	Trigger pulse width detection	Setting by trigger pulse width
Gain	0 dB to 18 dB	
Partial Scan	Variable, 2-line increments (more than 480 lines for XCL-C500)	
LUT (Look Up Table)	OFF/ON (Mode: 5 types)	
External trigger input	DIGITAL IF connector/DC IN connector	
Video output switch	Monochrome model: Mono 8/10/12-bit Color model: Raw 8/10/12-bit, RGB 24-bit	
Binning (Monochrome camera only)	2×1, 1×2, 2×2	
Defect correction	OFF/ON	
Shading correction	OFF/ON	

### Note

Make sure to supply power to the camera module and confirm that the camera module is operating before inputting a trigger signal. If you input trigger signal to a camera module without the power supplied, this may cause a malfunction of the camera module.

## Image at partial scan

Depending on the image input board of the camera you are using, if settings for the boards received image size and the image size output from a camera do not conform, picture noise or sync issues may occur.

## Communication Setting

The serial port assigned to the camera link board is used. The communication system is an asynchronous method compliant with RS-232C. The following table shows the transmission control specifications. Command inputs are echoed back. Inputs are not case-sensitive.

Baud rate	115200/ <u>57600</u> /38400/19200/9600 [bps]
Data bit	8
Parity	None
Stop bit	1
Flow control	None

Default values are underlined. (same applies hereinafter)

## Camera Link Tap

1tap output or 2tap output can be selected, regardless of the camera settings. Output clock frequencies are as follows. Lowering the output clock frequency improves the tolerance to video signal attenuation, which allows the camera link cable length to be extended. Thus, it is recommended to use with 2tap unless there are board restrictions. 2tap cannot be selected for RGB24-bit output.

command	param	XCL-C30/C	XCL-C32/C	XCL-C130/C	XCL-C280/C	XCL-C500/C
CAMERALINK-TAP	1	50MHz	40MHz	50MHz	81MHz	80MHz
	<u>2</u>	<u>25MHz</u>	<u>20MHz</u>	<u>25MHz</u>	<u>40.5MHz</u>	<u>40MHz</u>

# Data Order

Figures below show the data order when an image of  $M \times N$  pixels is transmitted in 1tap/2tap.

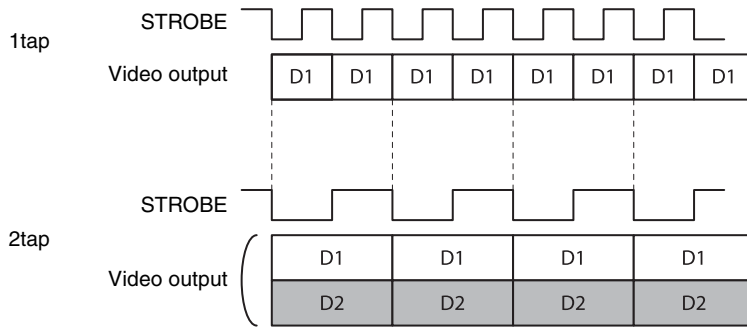

## 1tap

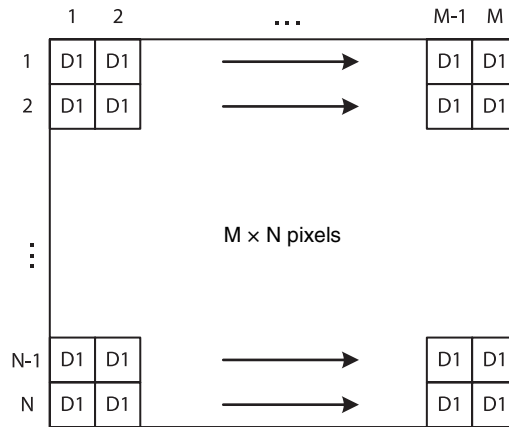

## 2tap

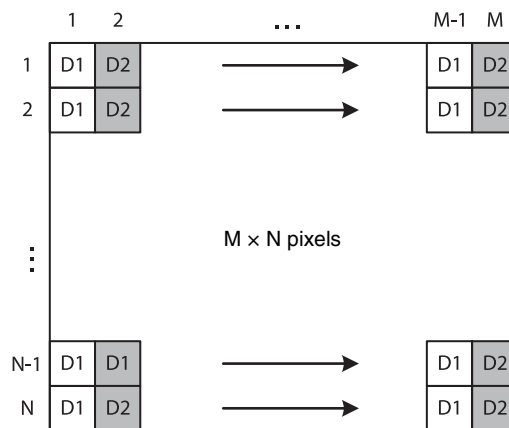

## Port assignment

The following table shows the assignment for the three ports (A, B, and C) and the respective video signals (D1, D2, and DR, DG, DB for RGB24-bit) for 1tap/2tap as defined in the base configuration.

Port	1tap				2tap		
	8 bit	10 bit	12 bit	RGB 24bit	8 bit	10 bit	12 bit
Port A0	D1[0]	D1[0]	D1[0]	DR[0]	D1[0]	D1[0]	D1[0]
Port A1	D1[1]	D1[1]	D1[1]	DR[1]	D1[1]	D1[1]	D1[1]
Port A2	D1[2]	D1[2]	D1[2]	DR[2]	D1[2]	D1[2]	D1[2]
Port A3	D1[3]	D1[3]	D1[3]	DR[3]	D1[3]	D1[3]	D1[3]
Port A4	D1[4]	D1[4]	D1[4]	DR[4]	D1[4]	D1[4]	D1[4]
Port A5	D1[5]	D1[5]	D1[5]	DR[5]	D1[5]	D1[5]	D1[5]
Port A6	D1[6]	D1[6]	D1[6]	DR[6]	D1[6]	D1[6]	D1[6]
Port A7	D1[7]	D1[7]	D1[7]	DR[7]	D1[7]	D1[7]	D1[7]
Port B0		D1[8]	D1[8]	DG[0]	D2[0]	D1[8]	D1[8]
Port B1		D1[9]	D1[9]	DG[1]	D2[1]	D1[9]	D1[9]
Port B2			D1[10]	DG[2]	D2[2]		D1[10]
Port B3			D1[11]	DG[3]	D2[3]		D1[11]
Port B4				DG[4]	D2[4]	D2[8]	D2[8]
Port B5				DG[5]	D2[5]	D2[9]	D2[9]
Port B6				DG[6]	D2[6]		D2[10]
Port B7				DG[7]	D2[7]		D2[11]
Port C0				DB[0]		D2[0]	D2[0]
Port C1				DB[1]		D2[1]	D2[1]
Port C2				DB[2]		D2[2]	D2[2]
Port C3				DB[3]		D2[3]	D2[3]
Port C4				DB[4]		D2[4]	D2[4]
Port C5				DB[5]		D2[5]	D2[5]
Port C6				DB[6]		D2[6]	D2[6]
Port C7				DB[7]		D2[7]	D2[7]

## Color pixel array

In the case of 8-bit, 10-bit, and 12-bit outputs, signals of all pixels are output sequentially according to the Bayer Array shown below.

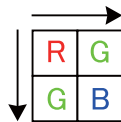

In the case of RGB24-bit, R, G, and B are 8 bits respectively per 1 pixel.

# Trigger Signal Input

Trigger signals can be input via the 7th, 10th, 11th pins of the DC IN connector, the CC1, CC2, CC3, CC4 pins of the Digital IF connector, or the software command. Switchover of the trigger signal can be changed via the TRG-SRC command.

command	param	Trigger signal assigned pin
TRG-SRC	7	DC IN connector 7th pin (GPI3)
	10	DC IN connector 10th pin (GPI2)
	11	DC IN connector 11th pin (GPI1)
	101	Digital IF connector 22nd [+] / 9th [-] (CC1)
	102	Digital IF connector 10th [+] / 23rd [-] (CC2)
	103	Digital IF connector 24th [+] / 11th [-] (CC3)
	104	Digital IF connector 12th [+] / 25th [-] (CC4)
	0	Software command (TRG-SOFT)
	20	OR of GPI1/GPI2/GPI3

## Trigger signal polarity

Positive refers to a trigger signal polarity activated while rising from Low to Hi, or during the Hi interval. Negative refers to a trigger signal polarity activated while falling from Hi to Low, or during the Low interval. The default value of a camera is Negative. The GPI connectors 1, 2, and 3 are pulled up on the camera side. When a connector is open, the trigger signal is at the high level and is logically inactive. Note that when Positive of GPI1, 2 or 3 is selected as a trigger input, when the terminal is open, the trigger will be activated.

command	param	Trigger signal polarity
TRG-POL	0	Negative
	1	Positive

## DC IN connector specifications

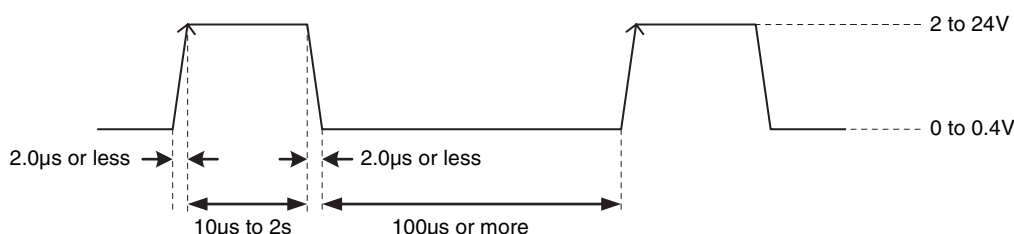
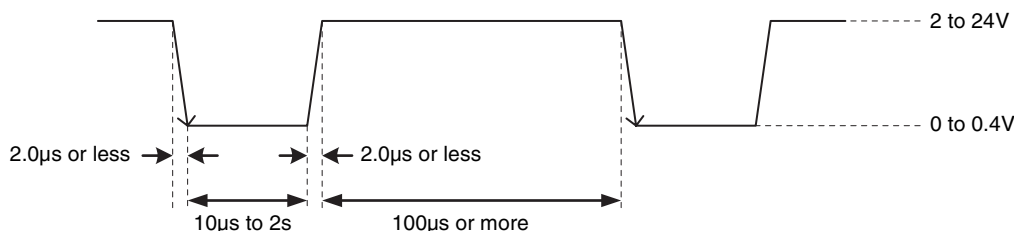

**Note**

When inputting a trigger signal to the camera using the DC-700/CE, use DC 5 V or less at the logical high level.

## Digital IF connector specifications

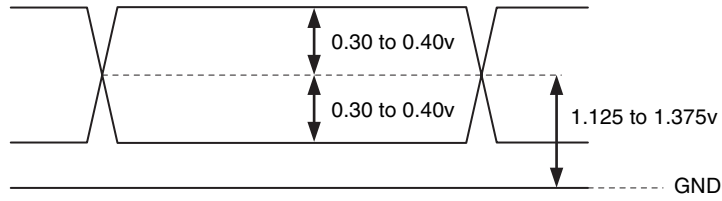

## GPIO Connector

The DC IN connector 7th, 10th, 11th are the GPI connector and the 4th, 6th, 9th are the GPO connector. The trigger reset pin is the DC IN connector 11th pin (GPI1). If you are connecting an external device to the GPI or GPO connector, refer to the circuit specifications below.

### GPI circuit specifications

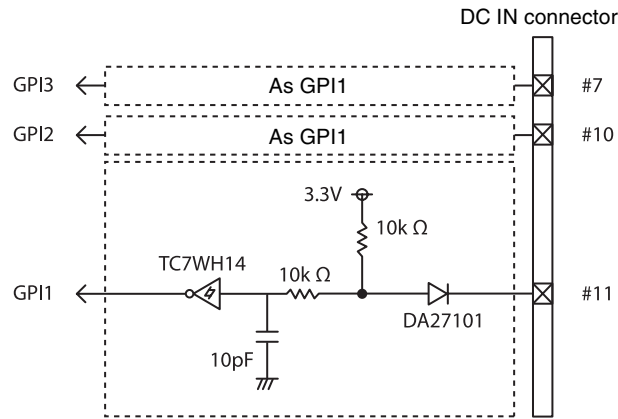

### GPO circuit specifications

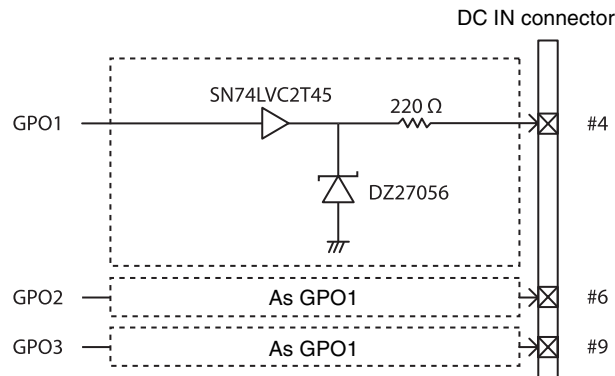

## Partial Scan

Only the area selected from the effective pixel area can be read out. Clearing unnecessary parts at high-speed allows high-speed reading. The area size is selected by the HEIGHT and WIDTH commands, and the read beginning point is selected by the OFFSETX and OFFSETY commands. Using the ROI command, you can set HEIGHT, WIDTH, OFFSETX and OFFSETY at the same time. Reducing HEIGHT increases the frame rate, but changing WIDTH does not change the frame rate. Partial scan can be set with or without a trigger. Binning can be used at the same time.

OFFSETX and OFFSETY relate to WIDTH and HEIGHT as follows:

$OFFSETX + WIDTH \leq WIDTH$  (maximum value)

$OFFSETY + HEIGHT \leq HEIGHT$  (maximum value)

### Note

Since the shutter setting has priority, use a shutter speed high enough to enable partial scan at a higher frame rate.

### Configurable range

	WIDTH	HEIGHT
<b>XCL-C30/C</b>	16 to 658	2 to 494
<b>XCL-C32/C</b>	16 to 658	2 to 494
<b>XCL-C130/C</b>	16 to 1296	2 to 966
<b>XCL-C280/C</b>	16 to 1940	2 to 1460
<b>XCL-C500/C</b>	16 to 2456	480 to 2058

### Configurable values

The values of OFFSETX, OFFSETY, WIDTH and HEIGHT increase or decrease in steps of 2.

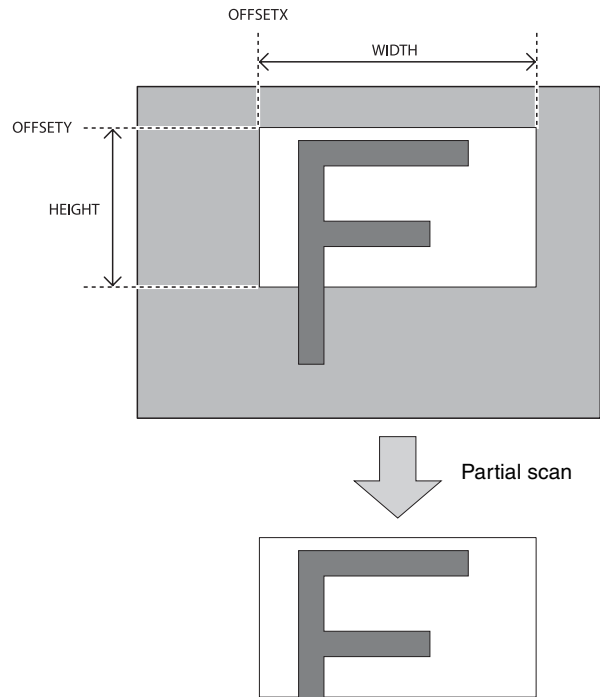

command	param1	param2	param3	param4
ROI	Width	Height	OffsetX	OffsetY

## Binning

By adding 2 vertical pixels or 2 horizontal pixels, the frame rate in vertical binning is increased along with the sensitivity. The color camera cannot set this. This can be set with or without a trigger. Partial scan can be used concurrently and horizontal and vertical can be set at the same time. The XCL-C500 can perform vertical binning only when Height is  $\geq 2048$ .

command	param	Setting
VBIN	<u>1</u>	No binning
	2	Vertical binning
HBIN	<u>1</u>	No binning
	2	Horizontal binning

## Sensor Tap

### Switching sensor tap

XCL-C280/C has a CCD with 2-channel output. Reading speed is faster in 2-channel output than 1-channel output. Although XCL-C500/C has a CCD with 2-channel output, the number of sensor taps cannot be switched.

command	param	Setting
SENSOR-TAP	1	1-channel
	<u>2</u>	<u>2-channel</u>

## Level correction between sensor taps

Since XCL-C280/C and XCL-C500/C have a CCD with 2 channel signal outputs, output level differences may occur during 2-channel reading due to the characteristic difference between channels. Level correction between sensor taps can correct the level differences. A command for one-push (automatically detecting the level difference and adjusting only once), continuous (constantly detecting the level difference and adjusting continuously), and manual correction (correcting left and right manually) is provided. After one-push is performed once, the state returns to manual designation.

command	param	Setting
BLACKLEV EL-AUTO- BALANCE (BL-AB)	<u>0</u>	<u>Manual designation</u>
	1	One-push (only once)
	2	Continuous (consecutive)

Manual designation is performed by the BL-ADJ-1/2 command. The left screen is for TAP1 and the right screen is for TAP2. One push and continuous commands automatically set the value for TAP2.

command	param	Setting
BL-ADJ-1	-255 to <u>0</u> to 255	Black level correction value for left screen
BL-ADJ-2	-255 to <u>0</u> to 255	Black level correction value for right screen

## Adjusting level correction between sensor taps

The one-push command should be executed after setting the output level to all black by removing light sources. When One-push or Continuous is performed as taking an image normally, the shade difference of an object is detected as the level difference between taps and level correction may not work properly on rare occasions. In this case, the limit value (BL-AB-LIMIT) should be adjusted so that the level is automatically adjusted to the proper value. Lowering the value allows preventing excessive detection but interferes the normal level correction between taps to work properly. The level should be adjusted accordingly since the optimal value differs depending on the environment (such as an object and light source) and camera settings (such as gain and shutter).

command	param	Setting
BL-AB-LIMIT	1 to <u>512</u> to 16383	Setting lower value prevents excessive detection

## Output Bit Depth

Monochrome cameras can switch between 8 bits, 10 bits, and 12 bits. Color cameras can switch between Raw output 8 bits, 10 bits, 12 bits, and RGB output 24 bits.

command	param	Setting
PIXEL-DEPTH	<u>8</u> /10/12/24	24 is only for color camera

## Gain

### Analog gain

The analog gain can be set finely in 1 dB unit or bit level (up to 18 dB). It can be set per the sensor tap as well.

command	param	Setting
GAIN	<u>0</u> to 18	Gain dB unit (full screen)
GAIN-TAP1	<u>0</u> to 18	Gain dB unit (left screen)
GAIN-TAP2	<u>0</u> to 18	Gain dB unit (right screen)
GAIN-FINE	<u>0</u> to 512	Gain advanced setting (full screen)
GAIN-FINE-TAP1	<u>0</u> to 512	Gain advanced setting (left screen)
GAIN-FINE-TAP2	<u>0</u> to 512	Gain advanced setting (right screen)

### Digital gain

The digital gain is not implemented in this device.

### Auto gain (AGC)

By executing the GAIN-AUTO command, the gain is automatically adjusted according to the image pickup environment. AGC works so that the average level in a detection frame may reach AGC-LEVEL. The AGC detection frame is set to the central region by default. The detection frame can be displayed or the detection area changed.



command	param	Setting
GAIN-AUTO (AGC)	<u>0</u>	Manual gain
	1	One-push AGC
	2	Continuous AGC
AGC-LEVEL	0 to <u>11264</u> to <u>16383</u>	AGC target level (14 bit)
AGC-SPEED	1 to <u>256</u>	AGC convergence speed
AGC-UPPER	0 to <u>18</u>	AGC upper limit (dB)
AGC-LOWER	<u>0</u> to 18	AGC lower limit (dB)
AGC-FRAME-HIGHLIGHT	<u>0</u>	AGC detection frame is hidden
	1	AGC detection frame is displayed

command	param1	param2	param3	param4
AGC-FRAME	1 to 100	1 to 100	0 to 99	0 to 99

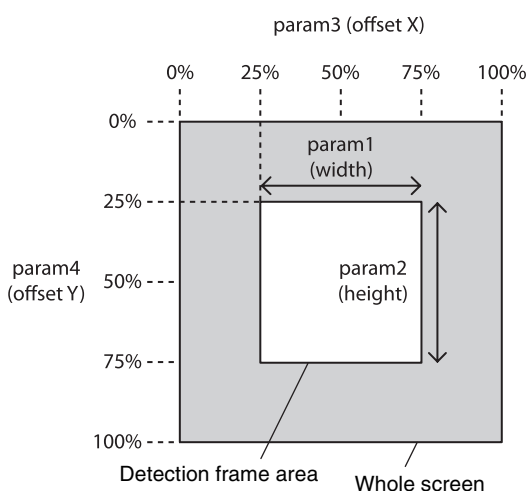

## Shutter (Exposure)

### Configuring the setting

The setting is configured in  $\mu\text{s}$  unit. With the default shutter value, the frame rate is maximized. During free run operation, the frame rate is reduced by setting a value bigger than the default shutter value.

command	param
EXP	10 to 2000000

	EXP [ $\mu\text{s}$ ]	Rate [fps]
<b>XCL-C30/C</b>	<u>7674</u>	130
<b>XCL-C32/C</b>	<u>9593</u>	104
<b>XCL-C130/C</b>	<u>32169</u>	31
<b>XCL-C280/C</b>	<u>37880</u>	26
<b>XCL-C500/C</b>	<u>64825</u>	15

### Auto exposure (AE)

The shutter is set automatically by detecting the output level. The target level is the same as the value of AGC-LEVEL. This can be performed along with auto gain.

command	param	Setting
EXPOSURE-AUTO (AE)	<u>0</u>	Manual shutter
	1	One-push AE
	2	Continuous AE
AE-SPEED	1 to <u>192</u> to 256	AE convergence speed
AE-UPPER	10 to 2000000	AE upper limit
AE-LOWER	10 to 2000000	AE lower limit

## Combination of Continuous AGC and Continuous AE

AGC and AE coordinate with each other to adjust the level automatically with AGC-LEVEL as the target level. When the environment starts getting dark and the shutter is released, AGC starts to work.

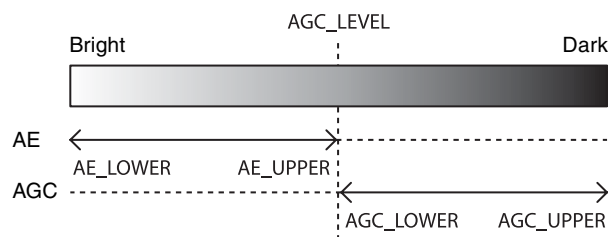

# Trigger Control

## Free run/trigger mode

### Free run

The camera operates without a trigger signal and performs the video output operation continuously after the shutter (exposure) is finished. The horizontal and vertical timing signals are generated within the camera. During the free-run operation, image pickup timing cannot be controlled. In the free-run operation, the adjustment is made automatically to achieve the maximum frame rate according to the shutter setting.

### Trigger mode

Exposure is started by detecting the externally input trigger signal. When EXP-MODE is 0, exposure is started by detecting the rising or falling edge of the trigger signal and the trigger edge detection (exposure is performed based on the set shutter value) is performed. When EXP-MODE is 1, the trigger width detection (exposed for the period of the trigger signal width) is performed.

command	param	Setting
TRG-MODE	0	Free run
	1	Trigger mode

### For trigger mode (TRG-MODE=1)

command	param	Setting
EXP-MODE	0	Trigger edge detection
	1	Trigger width detection

### Trigger edge detection

The figure shows the trigger signal negative polarity (detecting the drop edge).

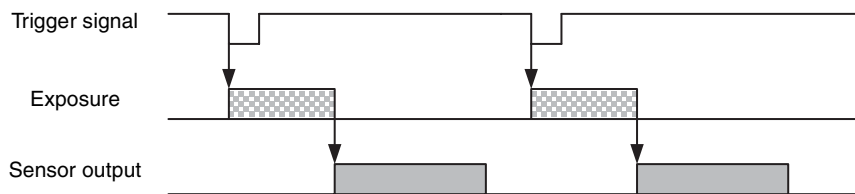

### Trigger width detection

The figure shows the trigger signal negative polarity (detecting Low level width).

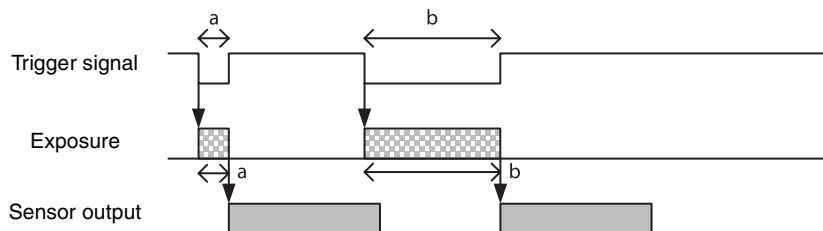

## Special trigger

When operating in trigger mode and performing image pickup in different conditions (such as the shutter, gain, and image pickup area), the setting has to be changed in advance for each trigger input. However, if the special trigger operation is enabled, the setting does not have to be changed and continuous image pick up in different conditions is facilitated. Up to 16 settings can be configured. There are the bulk operations in which images are taken consecutively by inputting the trigger signal once and the sequential operation in which images are taken each time the trigger signal is detected. The next exposure is started after the end of video output. In the sequential operation, the second and subsequent trigger signals should be input 5 ms or more after the end of video output. During the special trigger operation, the device cannot be entered to the trigger mode. The source and polarity of the special trigger signal should be defined separately from the trigger mode. Each setting should be saved in the user set. For the items reflected, refer to “Command List” (page 41).

### Note

During special trigger operation, defect correction cannot be used.

command	param	Setting
SP-TRG-MODE	0	Special trigger off
	1	Bulk
	2	Sequential

command	param	Setting
SP-TRG-SRC	7	DC IN connector 7th pin (GPI3)
	10	DC IN connector 10th pin (GPI2)
	11	DC IN connector 11th pin (GPI1)
	101	Digital IF connector 22nd [+] / 9th [-] (CC1)
	102	Digital IF connector 10th [+] / 23rd [-] (CC2)
	103	Digital IF connector 24th [+] / 11th [-] (CC3)
	104	Digital IF connector 12th [+] / 25th [-] (CC4)
	0	Software command (TRG-SOFT)
	20	OR of GPI1/GPI2/GPI3

command	param	Setting
SP-TRG-POL	0	Negative
	1	Positive

### Bulk

SP-TRG-MODE=1, SP-TRG-POL=0, SP-TRG-F-CNT=3 in the figure.

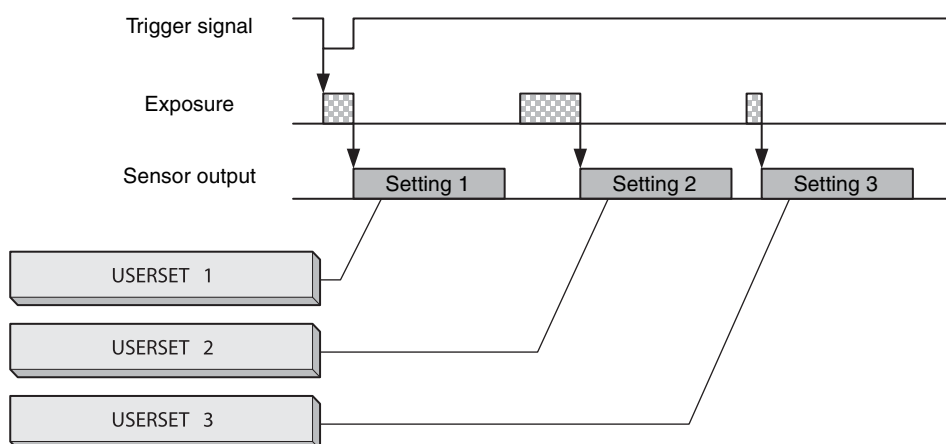

## Sequential

SP-TRG-MODE=2, SP-TRG-POL=0, SP-TRG-F-CNT=3 in the figure.

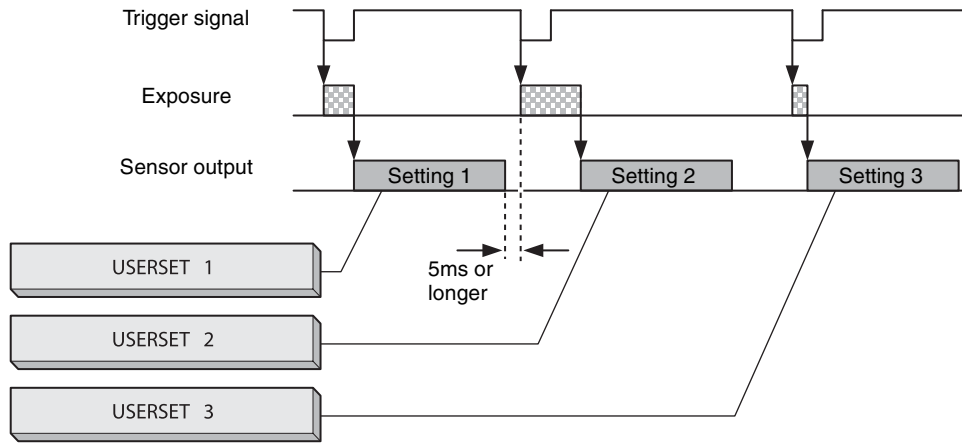

## Trigger states

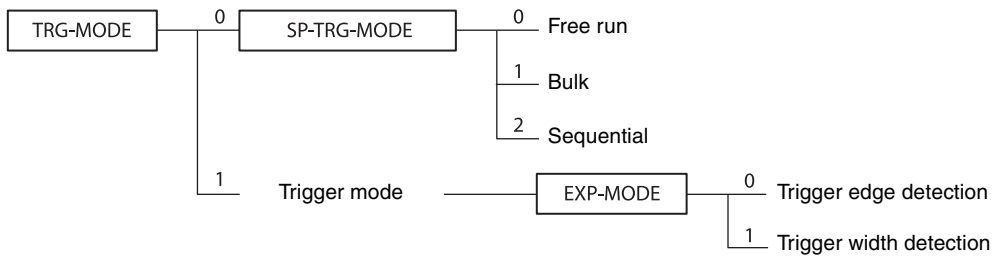

## Trigger source

This can be input via the DC IN connector, Digital IF connector, or software command (TRG-SOFT). Refer to “Trigger Signal Input” (page 13) for details. Note that the trigger sources for the special trigger operation and the trigger mode operation are defined separately.

## Trigger inhibition

Trigger input can be disabled. This function is effective when disabling the trigger signal to a specific camera in the environment where multiple cameras are connected by the same trigger signal and when preventing false operations caused by noise contamination to the trigger signal line (due to the installed environment).

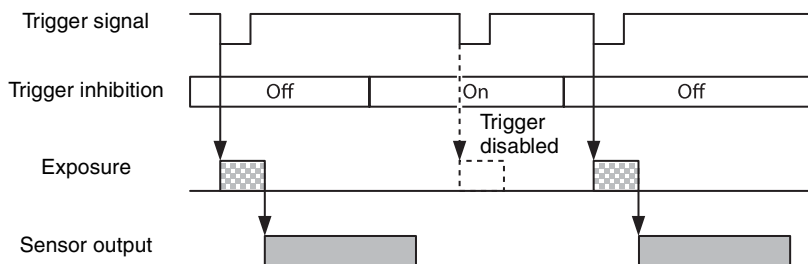

command	param	Setting
TRG-INH	0	<u>Trigger is accepted</u>
	1	Trigger is not accepted

## Trigger shift

This device can accept exposure by the next trigger even while a video is output (except for the special trigger operation). In this case, trigger shift should be enabled since the trigger signal can become a noise source. When trigger shift is enabled, adjustment is made automatically for operations from trigger input to exposure to prevent noise contamination. Therefore, the time from trigger input to exposure start will be delayed up to 1 line. When disabling trigger shift, this delay adjustment is not made and exposure is started consistently at the constant timing but noise may occur in the image. Even when the trigger shift is enabled, the next video cannot be output before completing video output and the trigger is disabled. Therefore, the exposure time setting (in the trigger edge operation), the effective period of the trigger signal width to be input (in the trigger width operation), or the trigger interval should be sufficiently long.

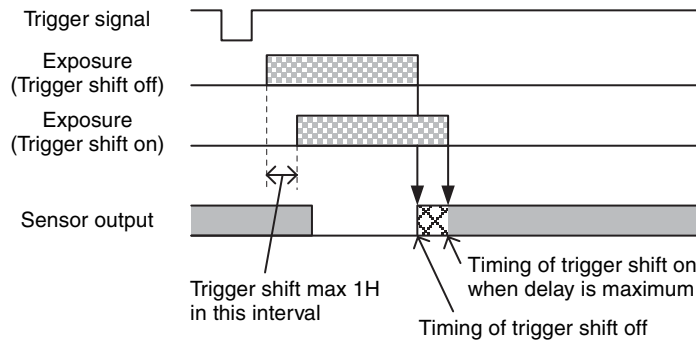

### When the next image can be output

Since video output is completed after the exposure is finished, the next video output can be started.

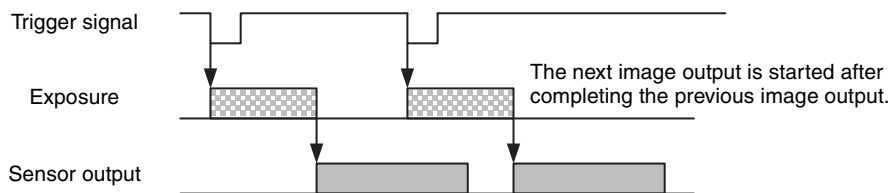

### When the next image cannot be output (double exposure)

Since video output is not completed after the exposure is finished, the next video output cannot be started. The input trigger becomes invalid.

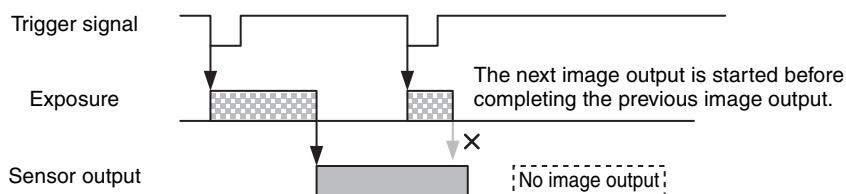

## Trigger delay

The camera can delay the trigger signal.

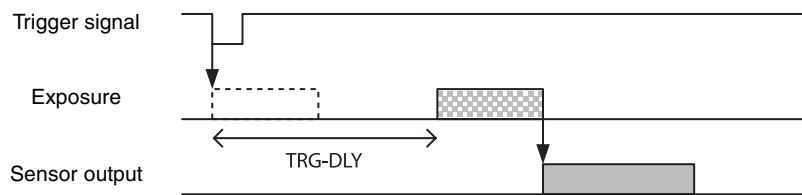

command	param	Setting
TRG-DLY	<u>0</u> to 4000000	Trigger delay [μs]

## Trigger counter

Accepted triggers by which video output is performed are counted. Triggers are counted up by the internal counter even in the free-run operation. Setting 0 resets the counter. Video output is not performed for triggers that coincide with the double exposure timing, but triggers are counted up. Triggers that have been removed by trigger range limit are not counted. The trigger counter returns to 0 when the upper limit (2147483647) is reached.

command
TRG-CNT

## Frame counter

The frame counter increases when an image is output. Setting 0 resets the counter. Frames whose image cannot be output due to triggers that coincide with the double exposure timing are not counted. The trigger counter returns to 0 when the upper limit (2147483647) is reached.

command
FRAME-COUNTER

## Trigger range limit

Only signals in the set trigger width can be accepted as the trigger signal. This functions as a noise filter, which removes chattering or disturbance noise in the trigger signal line. This also functions as a trigger selector, whereby only a specific camera can be operated by the trigger when multiple cameras share one trigger signal line. When the trigger signal is input, exposure is started immediately to increment the trigger counter; however, when trigger width is out of the range, video is not output and the trigger counter is decremented. If the shutter time is set shorter than the upper limit, triggers will be received and video is output even if the trigger signal is wider than the trigger range limit. If the trigger source is soft trigger, trigger range is not enabled.

command	param	Setting
TRG-RANGE	<u>0</u>	<u>Trigger range off</u>
	1	Trigger range on
TRG-RANGE-LOWER	<u>10</u> to 2000000	Trigger range lower limit [μs]
TRG-RANGE-UPPER	10 to <u>2000000</u>	Trigger range upper limit [μs]

### Trigger range operation example

EXP=300, TRG-RANGE-LOWER=100, TRG-RANGE-UPPER=200 in the figure.

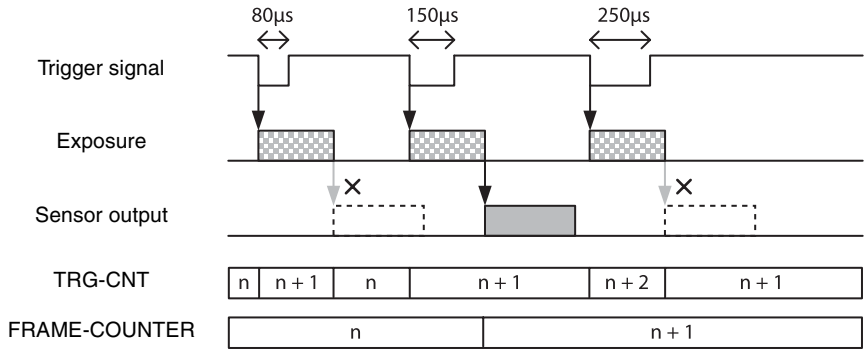

EXP=300, TRG-RANGE-LOWER=100, TRG-RANGE-UPPER=1000 in the figure.

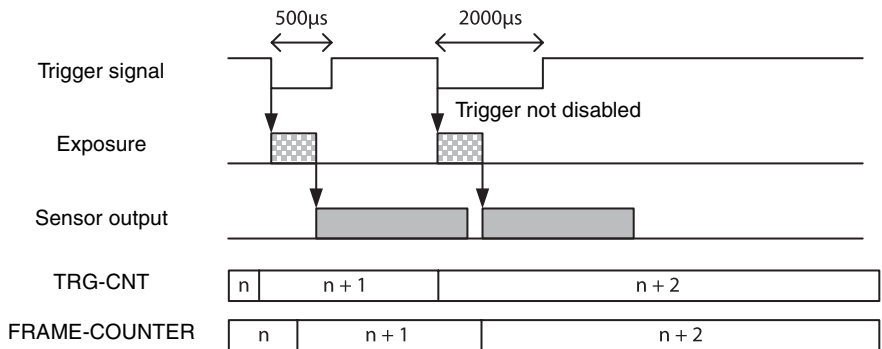

## Trigger control

Since detection of the trigger width time requires a certain time during the trigger width detection operation, the exposure time will be slightly longer than the input trigger width time. To perfectly match with the trigger signal width period, TRG-CTRL should be set to 0. TRG-SHIFT=1 and TRG-CTRL=0 cannot be set at the same time. Refer to “Trigger latency” (page 29) for details.

## Frame Rate

### Auto frame rate

The reading cycle is set to allow the frame rate to be the maximum value automatically according to the current shutter setting and the partial scan setting in the free-run operation (Shutter has priority). The next exposure is performed while outputting a video and the next video output is started immediately after finishing all video outputs. The frame rate is lowered when setting the shutter time longer than the video output time.

command	param	Setting
FRAMERATE-AUTO	0	Off
	<u>1</u>	<u>On</u>

---

## Specifying frame rate

The frame rate of the video output can be specified in the free-run operation. The value of the frame rate [fps] × 1,000,000 should be entered. The frame rate faster than the fastest frame rate cannot be set.

command	param
FRAMERATE	62500 to *

\* The upper limit varies depending on the partial scan setting.

Example for setting 15 [fps]: FRAMERATE 15000000

---

## Displaying frame rate

The current frame rate during the auto frame rate operation is displayed.

command
FRAMERATE-ACTUAL



## Fastest frame rate for partial scanning

The fastest frame rate varies depending on HEIGHT for partial scanning.

### XCL-C30/C

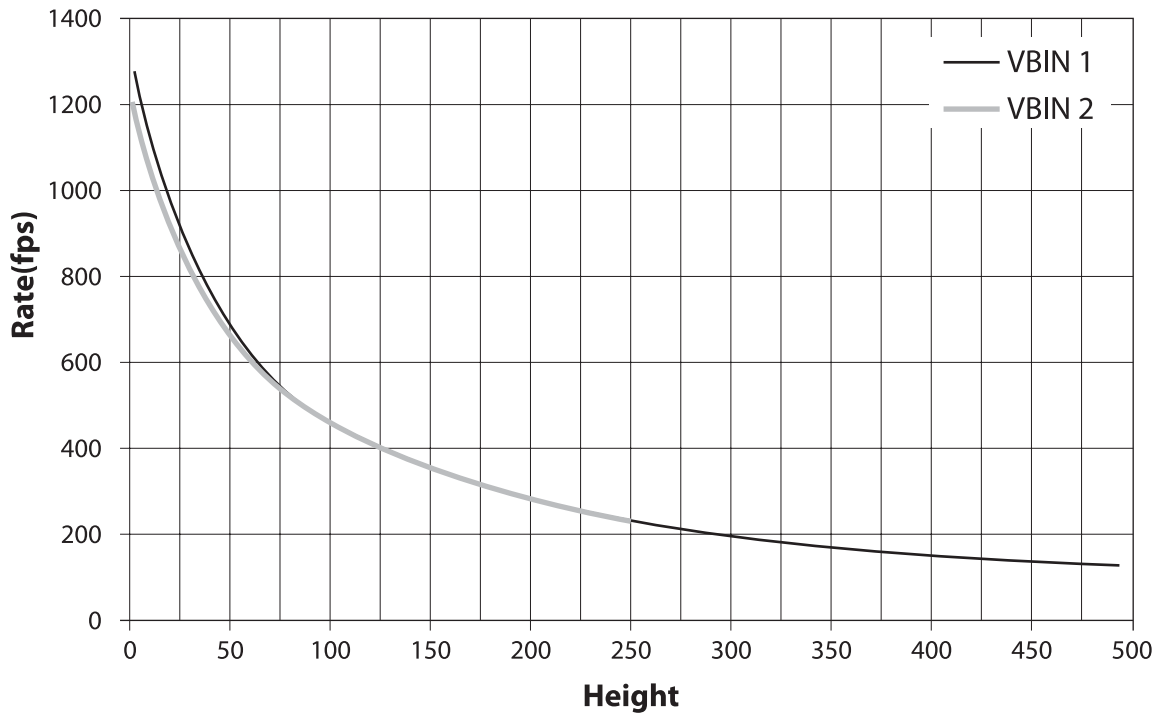

### XCL-C32/C

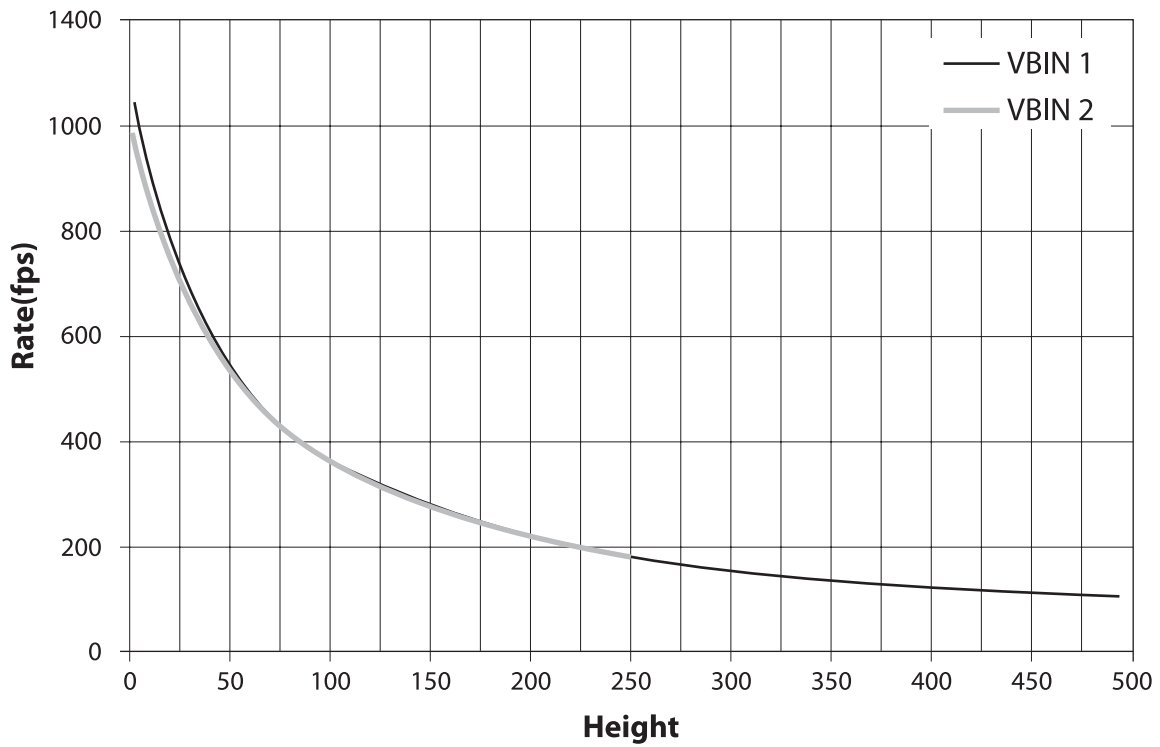

### XCL-C130/C

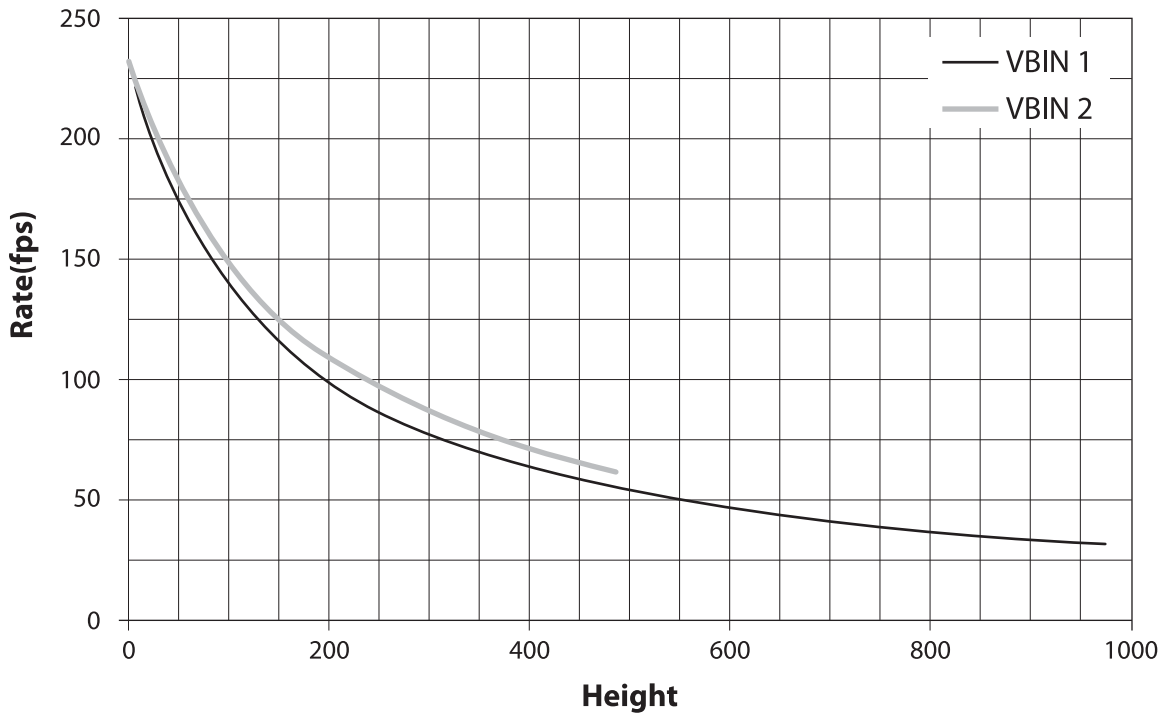

### XCL-C280/C (sensor-tap=2)

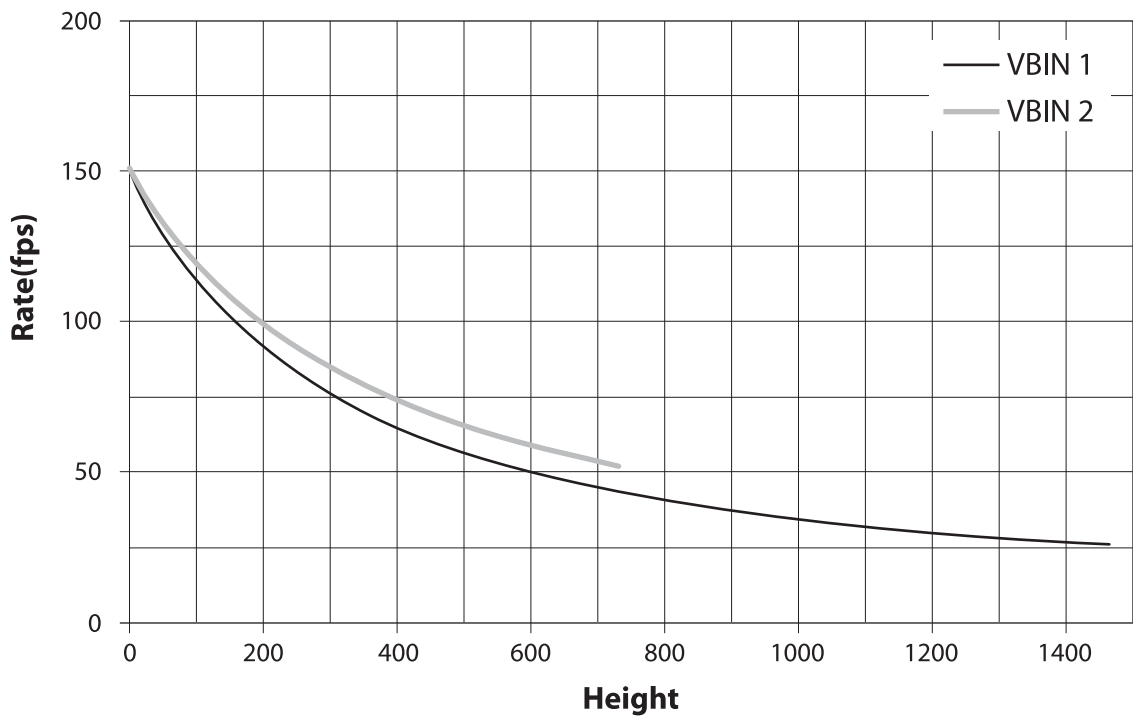

### XCL-C280/C (sensor-tap=1)

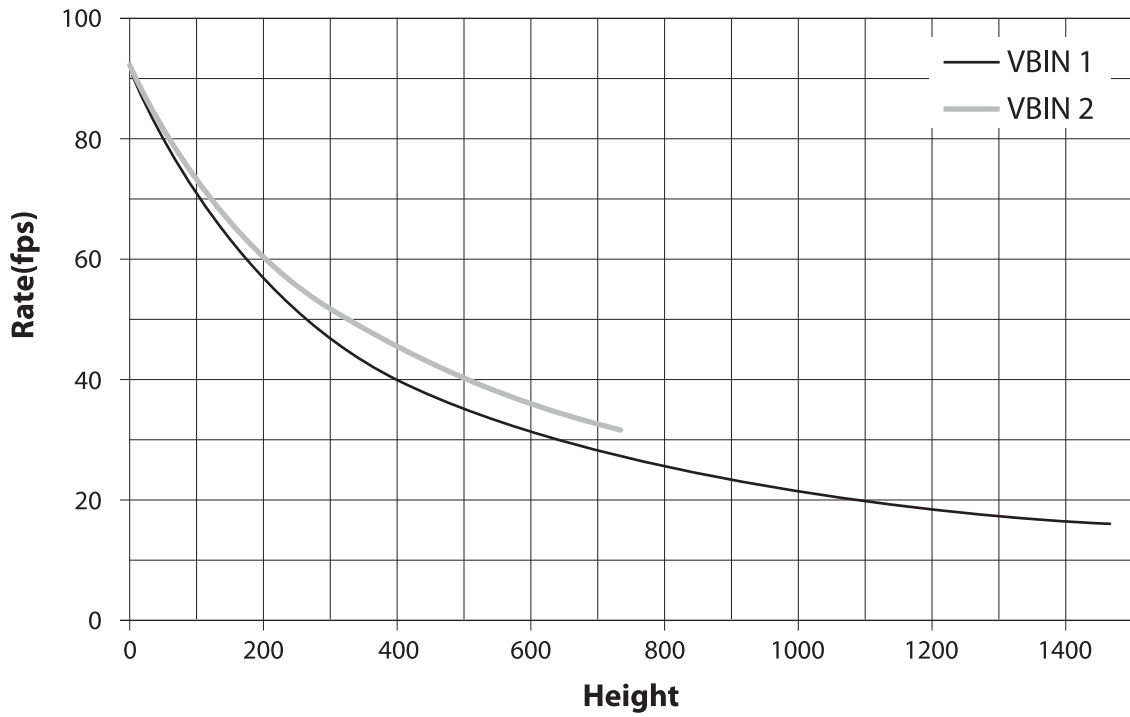

### XCL-C500/C

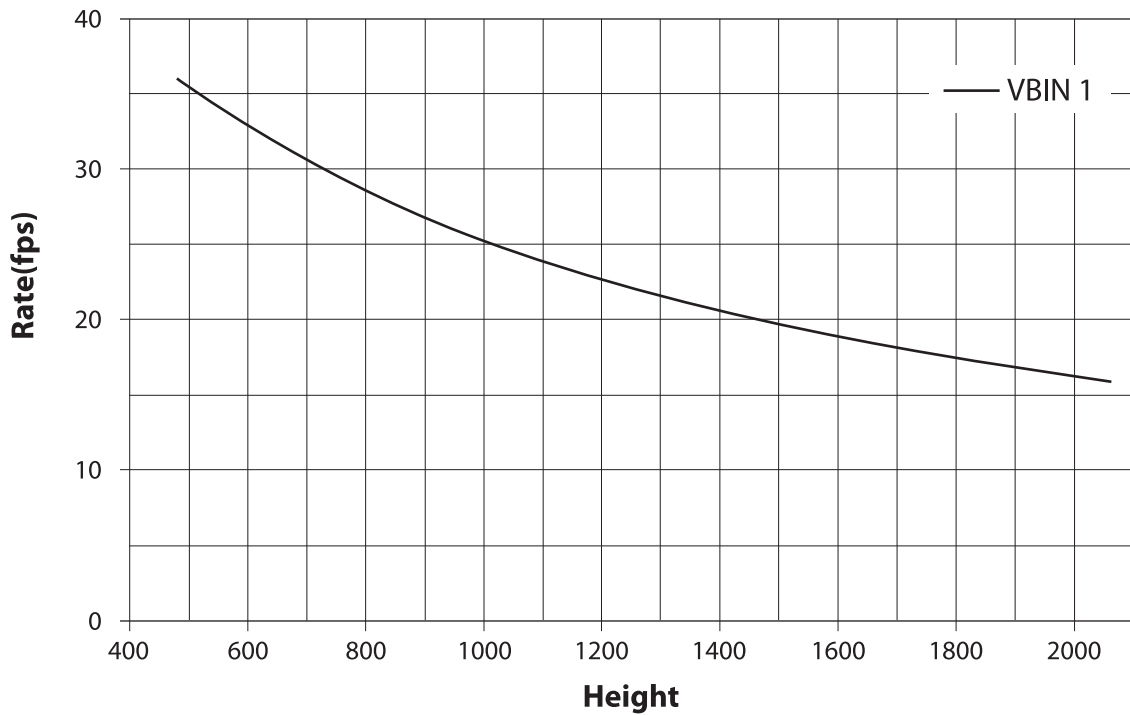

#### Note

The VBIN=2 setting is not available on color models.  
VBIN=2 setting for the XCL-C500 is only available when Height is  $\geq 2048$ .

# Timing Chart

## Horizontal timing

Constant regardless of the trigger mode, binning, and partial scanning. DVAL and LVAL are the same signal.

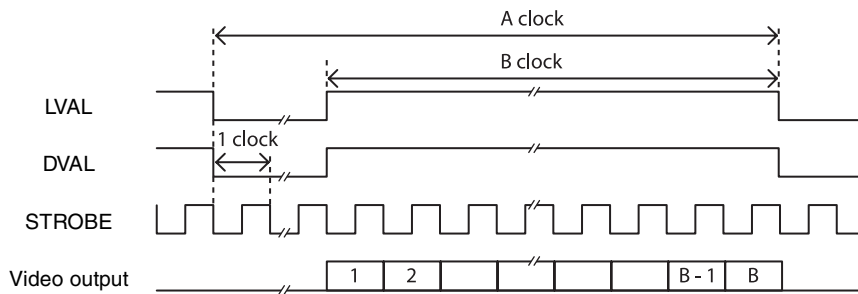

	sensor-tap	STROBE	A*	B*
XCL-C30/C	1	50MHz	780	WIDTH
XCL-C32/C	1	40MHz	780	
XCL-C130/C	1	50MHz	1660	
XCL-C280/C	1	54MHz	2365	
	2	81MHz	2106	
XCL-C500/C	2	80MHz	2520	

\* When CAMERALINK-TAP=1. The value will be half during 2tap output. Start time is shifted according to the OFFSETX value.

## Vertical timing

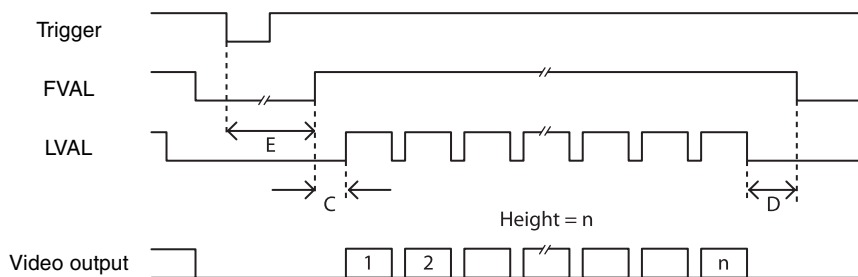

	sensor-tap	C	D
XCL-C30/C	1	22 + OFFSETX	780 - WIDTH - C
XCL-C32/C	1	22 + OFFSETX	780 - WIDTH - C
XCL-C130/C	1	22 + OFFSETX	1660 - WIDTH - C
XCL-C280/C	1	24 + OFFSETX	2365 - WIDTH - C
	2	24 + OFFSETX	2106 - WIDTH - C
XCL-C500/C	2	24 + OFFSETX	2520 - WIDTH - C

E: Varies depending on the EXP, OFFSETY value or trigger latency.

## Trigger latency

The time from the trigger acceptance to the exposure start (trigger latency) varies depending on various conditions. In the trigger width detection operation, the value is changed by TRG-CTRL.

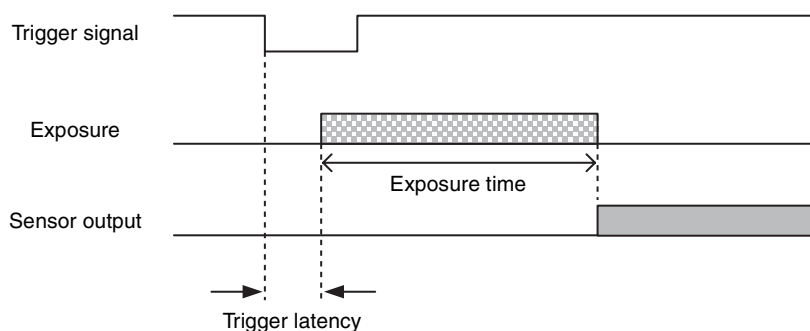

### XCL-C30/C

EXP-MODE	TRG-CTRL	TRG-SHIFT	Trigger latency	Exposure time
0 (edge detection)		0	Approx. 0.7 $\mu$ s	EXP
		1	Approx. 0.7 $\mu$ s to 16.3 $\mu$ s	EXP
1 (width detection)	0	0	Approx. 6.9 $\mu$ s	EXP
		1	Cannot be set*	
	1	0	Approx. 2.2 $\mu$ s	EXP + approx. 5 $\mu$ s
		1	Approx. 2.2 $\mu$ s to 18.8 $\mu$ s	EXP + approx. 5 $\mu$ s

### XCL-C32/C

EXP-MODE	TRG-CTRL	TRG-SHIFT	Trigger latency	Exposure time
0 (edge detection)		0	Approx. 0.8 $\mu$ s	EXP
		1	Approx. 0.8 $\mu$ s to 20.3 $\mu$ s	EXP
1 (width detection)	0	0	Approx. 8.7 $\mu$ s	EXP
		1	Cannot be set*	
	1	0	Approx. 2.8 $\mu$ s	EXP + approx. 6 $\mu$ s
		1	Approx. 2.8 $\mu$ s to 22.3 $\mu$ s	EXP + approx. 6 $\mu$ s

### XCL-C130/C

EXP-MODE	TRG-CTRL	TRG-SHIFT	Trigger latency	Exposure time
0 (edge detection)		0	Approx. 1.4 $\mu$ s	EXP
		1	Approx. 1.4 $\mu$ s to 34.6 $\mu$ s	EXP
1 (width detection)	0	0	Approx. 14.2 $\mu$ s	EXP
		1	Cannot be set*	
	1	0	Approx. 2.4 $\mu$ s	EXP + approx. 12 $\mu$ s
		1	Approx. 2.4 $\mu$ s to 35.6 $\mu$ s	EXP + approx. 12 $\mu$ s

### XCL-C280/C (SENSOR-TAP=2)

EXP-MODE	TRG-CTRL	TRG-SHIFT	Trigger latency	Exposure time
0 (edge detection)		0	Approx. 1.5 $\mu$ s	EXP
		1	Approx. 1.5 $\mu$ s to 27.5 $\mu$ s	EXP
1 (width detection)	0	0	Approx. 35 $\mu$ s	EXP
		1	Cannot be set*	
	1	0	Approx. 1.6 $\mu$ s	EXP + approx. 34 $\mu$ s
		1	Approx. 1.6 $\mu$ s to 27.6 $\mu$ s	EXP + approx. 34 $\mu$ s

**XCL-C280/C (SENSOR-TAP=1)**

EXP-MODE	TRG-CTRL	TRG-SHIFT	Trigger latency	Exposure time
0 (edge detection)		0	Approx. 1.5 $\mu$ s	EXP
		1	Approx. 1.5 $\mu$ s to 45.3 $\mu$ s	EXP
1 (width detection)	0	0	Approx. 53 $\mu$ s	EXP
		1	Cannot be set*	
	1	0	Approx. 1.6 $\mu$ s	EXP + approx. 52 $\mu$ s
		1	Approx. 1.6 $\mu$ s to 45.4 $\mu$ s	EXP + approx. 52 $\mu$ s

**XCL-C500/C**

EXP-MODE	TRG-CTRL	TRG-SHIFT	Trigger latency	Exposure time
0 (edge detection)		0	Approx. 1.5 $\mu$ s	EXP
		1	Approx. 1.5 $\mu$ s to 33 $\mu$ s	EXP
1 (width detection)	0	0	Approx. 27.4 $\mu$ s	EXP
		1	Cannot be set*	
	1	0	Approx. 1.7 $\mu$ s	EXP + approx. 26 $\mu$ s
		1	Approx. 1.7 $\mu$ s to 33.2 $\mu$ s	EXP + approx. 26 $\mu$ s

\* TRG-CTRL=0 and TRG-SHIFT=1 cannot be set at the same time.  
The settings will be discarded, and TRG-CTRL=1 and TRG-SHIFT=1 will be used.

# Sensor Readout (Sensor Output)

This signal indicates that exposure has completed and the CCD has entered the video output sequence, Output is available from the GPO1, 2 or 3 terminals. The sensor readout signal is asserted before optical black and the effective pixel area is output. If the following trigger signal is input when this signal is asserted, horizontal line noise may occur in an image. The trigger shift function (page 21) can effectively prevent noise contamination.

The time required for the CCD to start OB (optical black) and effective pixel output after sensor readout signal assertion is shown below. Moreover, when the CCD starts picture signal output, picture signals such as FVAL take at least as much time as is required for 4 to 4.5 lines. OB is not output from a camera.

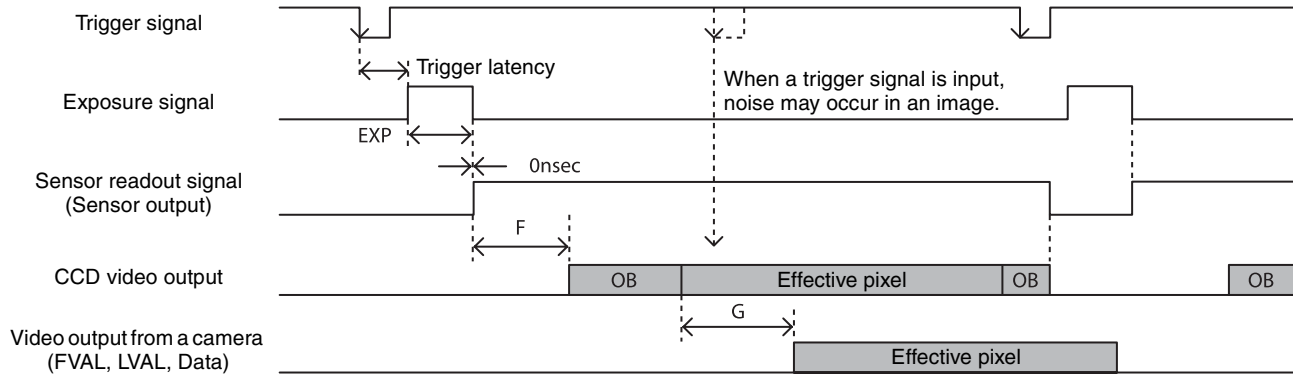

Functions

	sensor-tap	F	G**
<b>XCL-C30/C</b>	1	32 μs*	Approx. 4 H (16 μs x4)
<b>XCL-C32/C</b>	1	40 μs*	Approx. 4 H (19.5 μs x4)
<b>XCL-C130/C</b>	1	60 μs	Approx. 4 H (33.2 μs x4)
<b>XCL-C280/C</b>	1	88 μs	Approx. 4 H (44.4 μs x4)
	2	76 μs	Approx. 4.5 H (26 μs x4.5)
<b>XCL-C500/C</b>	2	47 μs	Approx. 4.5 H (31.5 μs x4.5)

\* When VBIN=2, increase of approximately 3 μs.  
 \*\* When OFFSETX= 0, OFFSETY= 0, shortest value.

# White Balance

The white balance can be automatically adjusted once when the WHITEBALANCE-AUTO command is executed. The detection area is set to the screen center by default. The detection area can also be displayed on the screen. The detection frame can be changed arbitrarily (AWB-FRAME). For manual correction, the FINE command should be executed. The white balance can be set finely per sensor tap. Therefore, a fine adjustment should be made if the color difference between sensor taps cannot be adjusted completely by AWB.

command	param	Setting
WHITEBALANCE-AUTO (AWB)	0	Manual correction
	1	One-push AWB
AWB-FRAME-HIGHLIGHT	0	Detection frame is hidden
	1	Detection frame is displayed

command	param	Setting
RGAIN-FINE	256 (x1) to 4095	Red gain
GGAIN-FINE	256 (x1) to 4095	Green gain
BGAIN-FINE	256 (x1) to 4095	Blue gain

### For reference

If the color offset between the left and right sensor taps cannot be cleared through fine adjustment using the FINE command, adjustment of the black level may work. Set the R, G, and B FINE levels to x1 (256), align the black levels, and then use the FINE command to make fine adjustments. This tends to occur in low temperature environments and when analog gain is set high.

# LUT

Five types of presets are provided. Specify using a 12 bit value. Binarization, 5-point interpolation, and arbitrary setting can be changed.

command	param	Setting
LUT-FORMAT	0	LUT off ( $\gamma=1$ )
	1	Reverse
	2	Binarization
	3	5-point interpolation
	4	Arbitrary setting

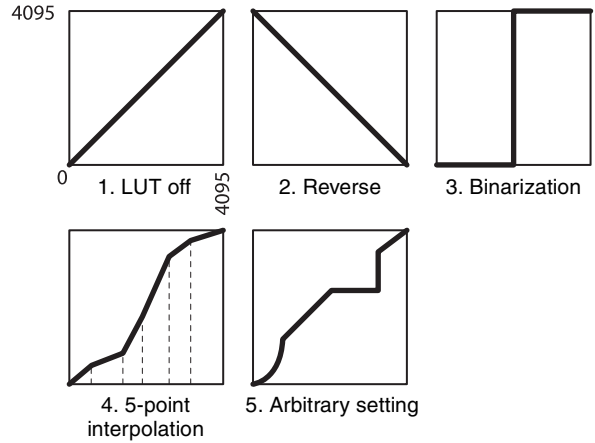

## Binarization

The binarization threshold can be changed.

command	param
BINARIZATION	0 to 2047 to 4095

## 5-point interpolation

The values of output points 1 through 5 that correspond to input points 1 through 5 can be changed. Linear interpolation is performed between interpolation points.

command	param1	param2	param3
LINEAR-INTERPOLATION	1 to 5	0 to 4095	0 to 4095

### Setting example:

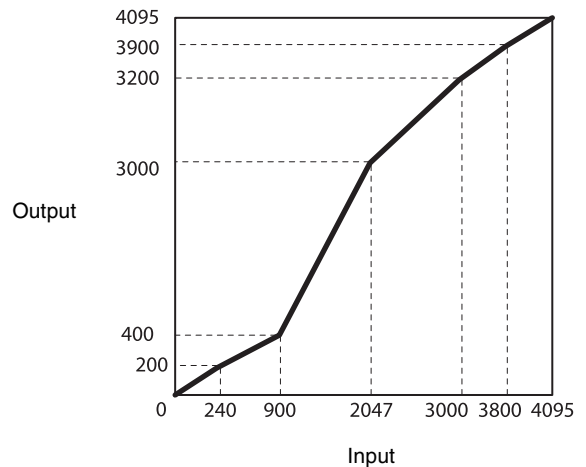

```
>LINEAR-INTERPOLATION 1 240 200
>LINEAR-INTERPOLATION 2 900 400
>LINEAR-INTERPOLATION 3 2047 3000
>LINEAR-INTERPOLATION 4 3000 3200
>LINEAR-INTERPOLATION 5 3800 3900
>LINEAR-INTERPOLATION-BUILD
>LUT-FORMAT 3
```



## Arbitrary setting

The output values 0 through 4095 that correspond to input values 0 through 4095 can be changed.

command	param1	param2
LUT	0 to 4095	0 to 4095

### Setting example:

```
>LUT 0 3
>LUT 1 10
>LUT 2 20
...
>LUT 4094 4000
>LUT 4095 4010
>LUT-FORMAT 3
```

## Save LUT

When you change the settings, save them using the LUT-SAVE command.

command
LUT-SAVE

## Color Matrix Conversion

During RGB output, the following color matrix conversion can be applied to the color model. Specify using values between -8191 and 8191. 256 is  $\times 1$ .

$$\begin{bmatrix} R \\ G \\ B \end{bmatrix} = \begin{bmatrix} Gain00 & Gain01 & Gain02 \\ Gain10 & Gain11 & Gain12 \\ Gain20 & Gain21 & Gain22 \end{bmatrix} \begin{bmatrix} R \\ G \\ B \end{bmatrix}$$

command	param	Setting
CR-TF	0	Conversion off
	1	Conversion on

command	param1	param2	Setting
CR-TF-VAL	00	-8191 to 256 to 8191	Gain00
	01	-8191 to 0 to 8191	Gain01
	02	-8191 to 0 to 8191	Gain02
	10	-8191 to 0 to 8191	Gain10
	11	-8191 to 256 to 8191	Gain11
	12	-8191 to 0 to 8191	Gain12
	20	-8191 to 0 to 8191	Gain20
	21	-8191 to 0 to 8191	Gain21
	22	-8191 to 256 to 8191	Gain22

## Test Chart Output

For monochrome model, monochrome chart can be set. For color model, monochrome chart or color chart can be set.

command	param	Setting
TESTCHAR T	0	Off
	1	Monochrome chart
	2	Color chart

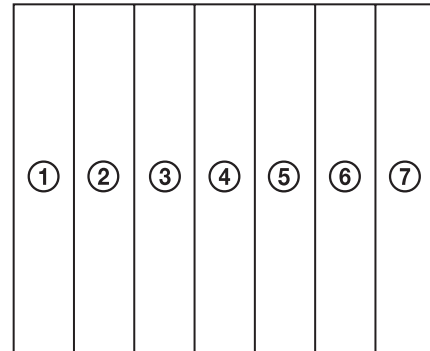

	Monochrome	Color		
	Raw/Mono	R	G	B
(1)	0xF30	0x3FF	0x3FF	0x3FF
(2)	0xDC0	0x3FF	0x3FF	0
(3)	0xC80	0	0x3FF	0x3FF
(4)	0xA00	0	0x3FF	0
(5)	0x7A0	0x3FF	0	0x3FF
(6)	0x550	0x3FF	0	0
(7)	0x340	0	0	0x3FF

\* 12 bit notation

## GPIO

### GPI

The value can be checked by detecting the signals input to the DC IN connector 7th, 10th, and 11th using the GPI command. Since all pins are pulled up, 1 (Hi level) is returned if they are opened.

command	param
GPI	7/10/11

## GPO

GPO1, GPO2, and GPO3 outputs can be transmitted from the DC IN connector 4th, 6th, and 9th pins, respectively. After selecting a signal, the output polarity should be determined by GPO-INVERTER. The strobe control signal can be set separately for GPO1, GPO2, and GPO3.

command	param1	param2	Setting
GPO-SRC	4/6/9	0	Exposure signal
		1	Strobe control signal
		2	LVAL signal
		3	FVAL signal
		4	Sensor readout signal
		5	Trigger through signal
		6	Pulse generation signal
		<u>7</u>	<u>User definition 1</u>
		8	User definition 2
		9	User definition 3

command	param	Setting
GPO-INVERTER	0	Without signal inversion
	<u>1</u>	<u>With signal inversion</u>

### Setting example:

LVAL signal is output to GPO2 (DC IN connector 6th pin), Hi active setting (Hi is enabled)  
>GPO-SRC 6 2  
>GPO-INVERTER 6 0

## GPO output system diagram (example of GPO1)

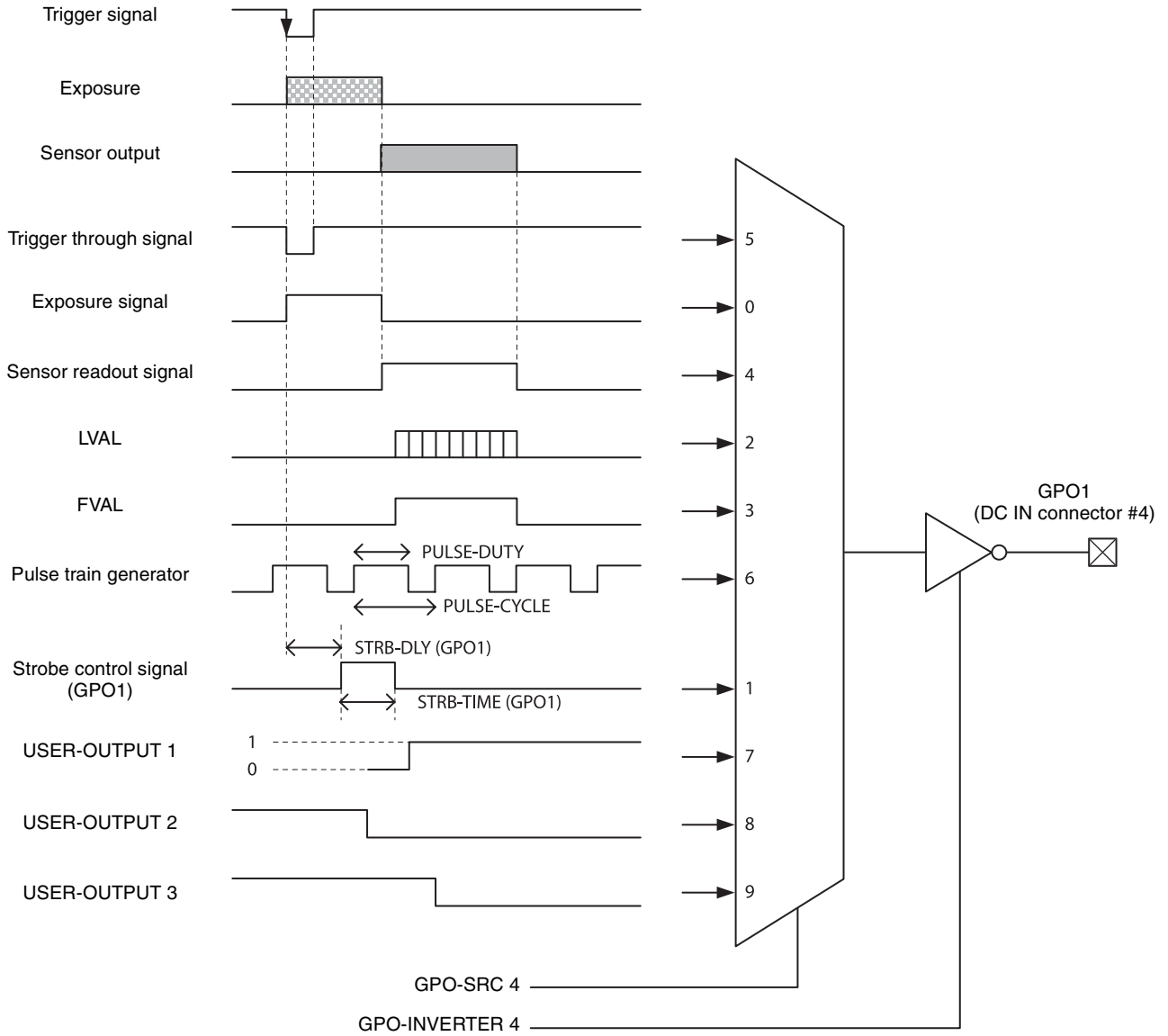

Functions

### Factory Setting

The following chart shows the factory setting for GPO1 (DC IN connector No.4). User-defined 1 is also set to GPO2 and GPO3 (Hi output).

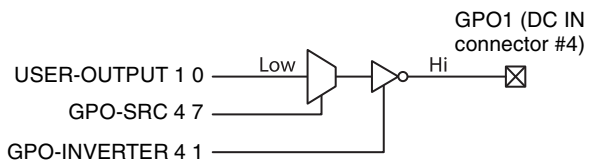

## Pulse Train Generator

Pulse waveforms can be output from the GPO1/2/3 connector. Available range is 0.5Hz to 100kHz.

command	param
PULSE-DUTY	1 to 2000000 [ $\mu$ s]
PULSE-CYCLE	10 to 2000000 [ $\mu$ s]

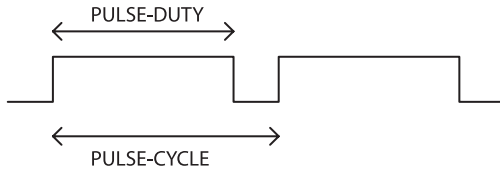

## Status LED

LED on the rear panel lights up according to the output specification set for GPO1/2/3 connector. Various settings are possible such as assigning the trigger signal and pulse train generator. The setting is saved immediately and reflected at the next startup.

command	param	Setting
LED-MODE	0	Off
	<u>1</u>	<u>On</u>
	2	GPO1 setting
	3	GPO2 setting
	4	GPO3 setting

## Temperature Readout Function

The camera's internal temperature can be read from the temperature sensor installed in the circuit board. Its accuracy is  $\pm 2^{\circ}\text{C}$ . Use this value as a general guide.

command
TEMPERATURE

## Defect Correction

It corrects clear defect points and opaque defect points which increase under the high/low temperature or when exposed for a long time (seconds). From the peripheral pixels, correction is performed on coordinate pixels in which defects are detected. Factory setting and user setting can be selected.

command	param	Setting
DEFECT-CORRECTION	<u>0</u>	<u>Correction off</u>
	1	Correction on

### Defect correction setup procedure

- 1 Set conditions in which clear defect points are prone to occur. Below is an example in which gain is 18 dB and the shutter is 1 second. Prevent as much light as possible from entering such as by blocking light.  
`>GAIN 18`  
`>EXP 1000000`
- 2 Set the threshold in units of 14 bits. Points are detected as clear defect points when this level is exceeded. Below is an example for 3200 step/14bit. Pixels that indicate 3200 to 16383 are detected.  
`>DEFECT-THRESHOLD 3200`
- 3 Execute clear defect point detection. Detection takes four times the EXP time setting. The output levels on the same x coordinate axis are shown below. The levels uniformly indicate around 1000 steps when an all-black image is taken, but defect pixels (at high levels) are present in some locations. All pixels whose levels exceed 3200 steps, which was set in step 2, are detected.  
`>DEFECT-DETECTION 1`

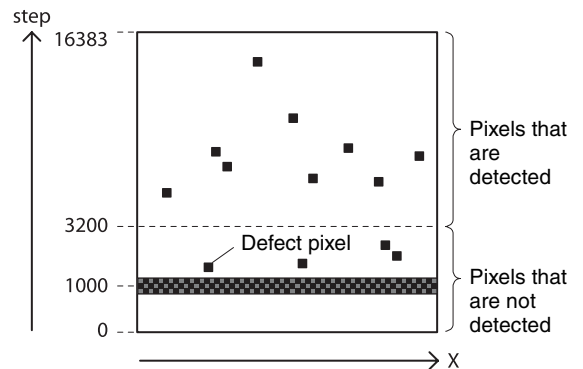

- 4** Execute opaque defect point detection. Like the clear defect point detection, set the image pickup conditions and the threshold in units of 14 bits. Below is an example for 10000 step/14bit. Pixels that indicate 0 to 10000 steps are detected. If are not setting opaque defect points, you can skip this step.  
 >DEFECT-THRESHOLD 10000  
 >DEFECT-DETECTION 2

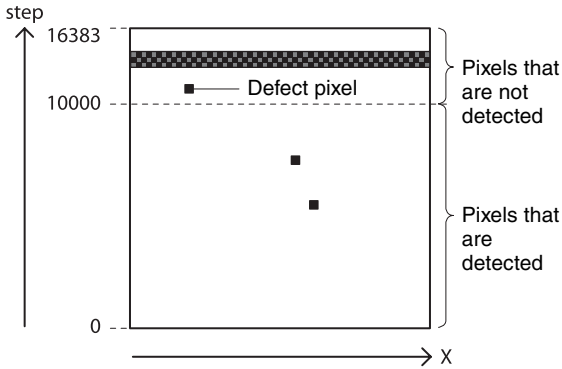

- 5** Select the data for applying defect correction. To apply the pixels detected in steps 3 and 4, select 2. To apply factory settings, select 0. To apply values that have been saved, select 1.  
 >DEFECT-PATTERN-LOAD 2

command	param	Setting
DEFECT-PATTERN-LOAD	0	Factory setting
	1	User setting
	2	Data detected using DEFECT-DETECTION

- 6** Turn on defect detection correction.  
 >DEFECT-CORRECTION 1

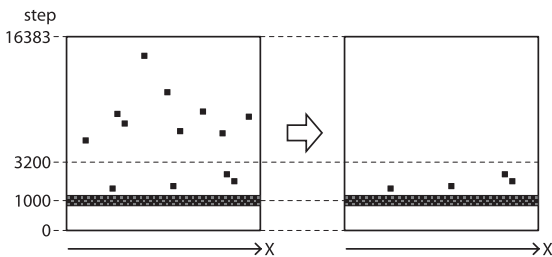

- 7** Save the settings. To repeat defect detection without saving, repeat steps 1 to 6.  
 >DEFECT-PATTERN-SAVE

**Note**

The upper limit of defect detection points is 2047 for clear and opaque defect points combined. Correction cannot be performed over the upper limit. The detected defect points can be confirmed using DEFECT-DETECTION-RESULT. If the upper limit is exceeded, defect detection will fail or abnormal defect detection will occur and RESULT will be -1.

# Shading Correction

Shadings caused by a drop in the amount of light around the lens or light source variation are corrected. Three sets of user settings can be saved.

command	param	Setting
SHADING-CORRECTION	0	Correction off
	1	Correction on

## Shading correction setup procedure

- 1** As shown in the figure below, assume an environment in which the brightness is not uniform due to an uneven light source. Shading correction adjusts the brightness levels taking the brightest level to be the target level.

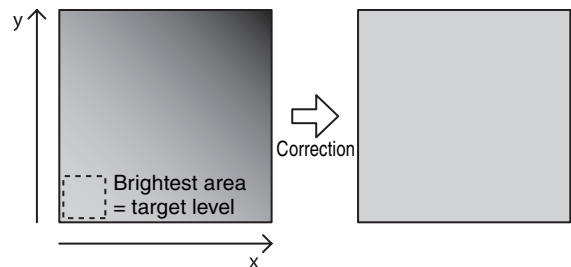
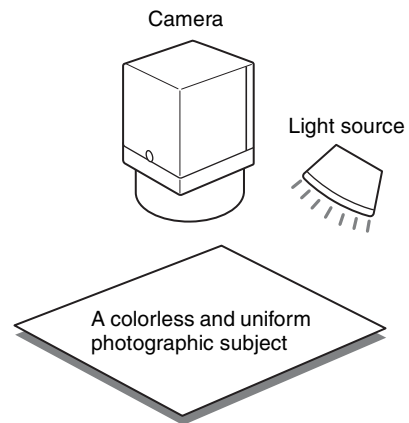

- 2** Adjust the exposure and other parameters so that the target level is about 50%. On color cameras, adjust the white balance.

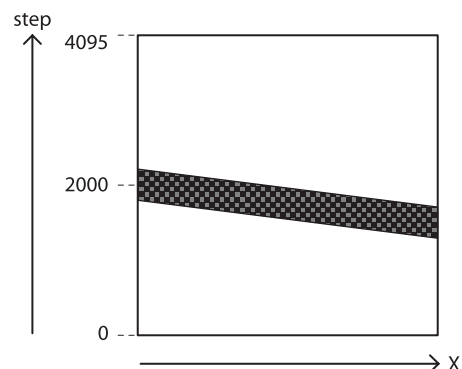

- 3 Execute shading detection.  
>SHADING-DETECTION 1
- 4 Select the data for applying shading correction. To apply the data detected in step 3, select 3. To apply values that have been saved, select 0, 1, or 2.  
>SHADING-PATTERN-LOAD 3

command	param	Setting
SHADING-PATTERN-LOAD	<u>0</u>	User setting 0
	1	User setting 1
	2	User setting 2
	3	Data detected using SHADING-DETECTION

- 5 Turn on shading correction.  
>SHADING-CORRECTION 1
- 6 Save the settings. Three sets of shading settings can be saved. To repeat shading detection without saving, repeat steps 1 to 5.  
>SHADING-PATTERN-SAVE 0

command	param	Setting
SHADING-PATTERN-SAVE	0	User setting 0
	1	User setting 1
	2	User setting 2

## Sensitivity Control

The VSUB (substrate bias voltage) in the CCD can be changed\*<sup>1</sup>. VSUB adjustment allows you to change the Qs (saturation signal charge) value. Increasing the VSUB has the effect of improving the sensitivity\*<sup>2</sup>. Therefore, when capturing a dark image but the exposure time cannot be extended, this has the effect of improving the image quality. On the other hand, decreasing the VSUB has the effect of reducing image smearing. The factory setting is adjusted to the optimal value. The default value is factory-adjusted on each XCL-C500/C before shipment.

\*<sup>1</sup> Not including XCL-C130 and XCL-C130C

\*<sup>2</sup> If Qs exceeds the maximum signal charge amount that can be transferred vertically and horizontally, a transfer error will occur, resulting in image smearing, etc.

command	param	Setting
VSUB-EXTERNAL-MODE	<u>0</u>	Sensitivity adjustment off
	1	Sensitivity adjustment on

command	param	Setting
VSUB-EXTERNAL	0 to 127	Sensitivity adjustment value

## User Set

Main set values can be saved to the channels 1 to 16 of USERSET. Refer to “Command List” (page 41) for items to be saved. The factory setting is saved to channel 0, which cannot be overwritten.

### Setting example (1):

Shutter 3 ms, Gain 3 dB, FVAL signal is output to GPO3 connector (This setting is saved to the channel 1.)  
>EXPOSURE 3000  
>GAIN 3  
>GPO 9 3  
>USERSET-SAVE 1

### Setting example (2):

The user set saved in the channel 2 is loaded.  
>USERSET-LOAD 2

## User set name

Strings that are 31 characters long can be assigned to channels 0 to 16. For example, you can assign names such as “setting1” and “setting2” in accordance with the settings.

command	param
USERSET-NAME	31 characters of your choice

## User set memory

This is one of the items to be saved in the user set channel. Signed 32-bit numbers are assigned to slots 0 to 15.

## Configuration diagram of user set

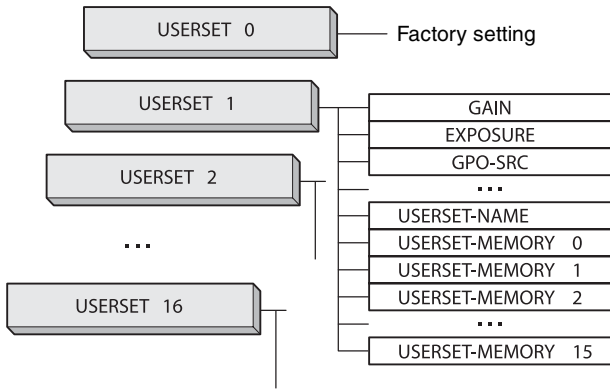

## Free Memory

Signed 32-bit numbers can be saved and loaded to 8192 areas.

command	param1	param2
FREE-MEMORY	0 to 8191	$-2^{31}$ to $2^{31} - 1$

## User ID

User IDs are unique names that can be assigned to cameras. A string that is 15 characters long can be assigned.

command	param
USER-ID	15 characters of your choice

## Saving and Startup

The startup setting can be determined by USERSET-DEFAULT. This is also used to check which user set settings are currently being used.

### Usage example:

```
Startup with the setting saved in the user set channel 3.
>USERSET-DEFAULT 3
(Restart or RESET command)
```

```
Check which user set settings are the current settings.
>USERSET-DEFAULT
0
OK
```

## Initializing

In the user settings, all settings, such as unsaved baud rate settings can be returned to the factory defaults. For details on initialized items, refer to “Command List” (page 41).

command
FACTORY-DEFAULT

## Camera Information

The model name of a camera or its firmware information can be read out.

command	Read out items
VENDOR	Manufacture name (SONY)
MODEL	Model name
VERSION	Firmware version
ID	Serial number
MANUFACTURER	Data for service

## Help Command

To display the command list, execute HELP. To display the details of a command, add HELP in front of the command and execute.

### Setting example:

```
Check about GAIN.
>HELP GAIN
GAIN:
Controls the analog gain (in dB).
This can take the value in following range:
min:0, max:18, step:1
OK
```

## Restart

The camera is rebooted.

command
RESET

## Command Form

When inputting commands, separate a command and a parameter by a space, and press [Enter] to confirm. Upper/lower case characters are not distinguished. Input format and an input example are shown below.

**Input format:**

Command Param1 param2 param3 Param4 [Enter]

**Input example:**

ROI 640 480 8 6 <CR>

## Command Input and Response

Camera echoes back against characters (alphabetic, numeric), space, backspace and Enter; otherwise, other invalid characters are ignored. When a command is successfully completed, the status will be echoed.

**Input:** Gain 6<CR>

**Output:** OK<CR>

Status	Explanation (Example)
OK	Successfully completed
ERROR: Invalid argument number.	The argument number of the parameter is invalid. (Width 100 100)
ERROR: Invalid parameter.	The parameter is invalid. (Width abc)
ERROR: Not implemented.	The command is not supported. (Vbin of a color camera)
ERROR: Access denied.	Commands are limited. (A trigger mode related command is controlled by SP-TRG-MODE=1.)
ERROR: Busy	The command cannot be received.
SYNTAX ERROR!	The command is not correct. (Widtt 100)



# Command List

<b>Save</b>	<b>Camera</b>	This item is saved in a different area to the user set.
<b>Load</b>	<b>UserSet</b>	This item is saved in the user set from 1-16.
<b>Reset</b>	<b>SpecialTrigger</b>	This item is set in the special trigger mode.
	<b>UserSet</b>	This item is set with the UserSet-load command.
	<b>Reset</b>	This item is initialized if a reset or reboot command is executed.
	<b>FactoryDefault</b>	This item is initialized if a Factory-Default command is executed.

Command	Parameter 1	Parameter 2	Parameter 3	Parameter 4	Camera		SpecialTrigger	Load	Reset	FactoryDefault
					Save	Reset				
VENDOR	-	-	-	-	-	-	-	-	-	-
MODEL	-	-	-	-	-	-	-	-	-	-
MANUFACTURER	-	-	-	-	-	-	-	-	-	-
VERSION	-	-	-	-	-	-	-	-	-	-
ID	-	-	-	-	-	-	-	-	-	-
USER-ID	15 characters	-	-	-	○	-	-	-	-	○
USER-ID-DELETE	-	-	-	-	-	-	-	-	-	-
RESET	-	-	-	-	-	-	-	-	-	-
TEMPERATURE	-	-	-	-	-	-	-	-	-	-
BAUDRATE	9600 / 14400 / 19200 / 38400 / 57600 / 115200	-	-	-	○	-	-	-	-	○
LED-MODE	0 / 1 / 2 / 3 / 4	-	-	-	○	-	-	-	-	○
VSUB-EXTERNAL-MODE*1	0 / 1	-	-	-	-	○	-	○	-	○
VSUB-EXTERNAL*1	0 ~ 127	-	-	-	-	○	-	○	-	○
SENSOR-WIDTH	-	-	-	-	-	-	-	-	-	-
SENSOR-HEIGHT	-	-	-	-	-	-	-	-	-	-
SENSOR-TAP*1	1 / 2	-	-	-	-	○	-	○	-	○
ROI*1	16 ~ : Width	2 ~ : Height	0 ~ : OffsetX	0 ~ : OffsetY	-	○	-	○	-	○
WIDTH*1	16 ~	-	-	-	-	○	-	○	-	○
HEIGHT*1	2 ~	-	-	-	-	○	-	○	-	○



Camera Control Commands



Command	Parameter 1	Parameter 2	Parameter 3	Parameter 4	Camera	UserSet	SpecialTrigger	UserSet	Reset	FactoryDefault
					Save	Load	Reset	Reset		
OFFSETX*1	0 ~	-	-	-	-	○	○	○	-	○
OFFSEY*1	0 ~	-	-	-	-	○	○	○	-	○
HBINNING / HBIN	1/2	-	-	-	-	○	-	○	-	○
VBINNING / VBIN	1/2	-	-	-	-	○	-	○	-	○
PIXEL-DEPTH	8 / 10 / 12 / 24	-	-	-	-	○	-	○	-	○
CAMERALINK-TAP	1/2	-	-	-	-	○	-	○	-	○
TESTCHART	0 / 1 / 2	-	-	-	-	-	-	-	○	○
FRAMERATE*1	62500 ~ *2	-	-	-	-	○	-	○	-	○
FRAMERATE-AUTO	0 / 1	-	-	-	-	○	-	○	-	○
FRAMERATE-ACTUAL		-	-	-	-	-	-	-	-	-
SPECIAL-TRIGGER-MODE / SP-TRG-MODE	0 / 1 / 2	-	-	-	-	-	-	-	○	○
SPECIAL-TRIGGER-FRAMECOUNT / SP-TRG-F-CNT	1 ~ 2 ~ 16	-	-	-	-	○	○	-	-	○
SPECIAL-TRIGGER-SOURCE / SP-TRG-SRC	0 / 7 / 10 / 11 / 20 / 101 / 102 / 103 / 104	-	-	-	-	○	○	-	-	○
SPECIAL-TRIGGER-POLARITY / SP-TRG-POL	0 / 1	-	-	-	-	○	○	-	-	○
TRIGGER-MODE / TRG-MODE	0 / 1	-	-	-	-	-	-	○	-	○
TRIGGER-SOURCE / TRG-SRC	0 / 7 / 10 / 11 / 20 / 101 / 102 / 103 / 104	-	-	-	-	-	-	○	-	○
TRIGGER-INHIBIT / TRG-INH	0 / 1	-	-	-	-	-	-	○	-	○
TRIGGER-POLARITY / TRG-POL	0 / 1	-	-	-	-	-	-	○	-	○
TRIGGER-SHIFT / TRG-SHIFT	0 / 1	-	-	-	-	-	-	○	-	○
TRIGGER-CONTROL / TRG-CTRL	0 / 1	-	-	-	-	-	-	○	-	○
TRIGGER-DELAY / TRG-DLY	0 ~ 4000000	-	-	-	-	-	-	○	-	○
TRIGGER-SOFTWARE / TRG-SOFT	0 / 1	-	-	-	-	-	-	-	-	-
TRIGGER-RANGE / TRG-RANGE	0 / 1	-	-	-	-	-	-	○	-	○

Command	Parameter 1	Parameter 2	Parameter 3	Parameter 4	Camera	UserSet	SpecialTrigger	UserSet	Reset	FactoryDefault
					Save	Load	Reset	Reset		
TRIGGER-RANGE-UPPERLIMIT / TRG-RANGE-UPPER	10 ~ 2000000	-	-	-	-	○	-	○	-	○
TRIGGER-RANGE-LOWERLIMIT / TRG-RANGE-LOWER	10 ~ 2000000	-	-	-	-	○	-	○	-	○
EXPOSURE-MODE / EXP-MODE	0 / 1	-	-	-	-	○	-	○	-	○
EXPOSURE / EXP*1	10 ~ 2000000	-	-	-	-	○	○	○	-	○
EXPOSURE-AUTO / AE	0 / 1 / 2	-	-	-	-	○	-	○	-	○
EXPOSURE-AUTO-SPEED / AE-SPEED	1 ~ 192 ~ 256	-	-	-	-	○	-	○	-	○
EXPOSURE-AUTO-UPPERLIMIT / AE-UPPER*1	10 ~ 2000000	-	-	-	-	○	-	○	-	○
EXPOSURE-AUTO-LOWERLIMIT / AE-LOWER	10 ~ 2000000	-	-	-	-	○	-	○	-	○
GPO-INVERTER / GPO-INV	4 / 6 / 9	0 / 1	-	-	-	○	○	○	-	○
GPI	7 / 10 / 11	-	-	-	-	-	-	-	-	-
GPO-SOURCE / GPO-SRC	4 / 6 / 9	0 / 1 / 2 / 3 / 4 / 5 / 6 / 7 / 8 / 9	-	-	-	○	○	○	-	○
STROBE-TIME / STRB-TIME	4 / 6 / 9	1 ~ 256 ~ 4000	-	-	-	○	○	○	-	○
STROBE-DELAY / STRB-DLY	4 / 6 / 9	0 ~ 100 ~ 4000	-	-	-	○	○	○	-	○
USER-OUTPUT	1 / 2 / 3	0 / 1	-	-	-	-	○	○	-	○
PULSE-CYCLE	10 ~ 1000000 ~ 2000000	-	-	-	-	-	○	○	-	○
PULSE-DUTY	1 ~ 500000 ~ 2000000	-	-	-	-	-	○	○	-	○
TRIGGER-COUNTER / TRG-CNT	-(0 : Reset)	-	-	-	-	-	-	-	○	○
FRAME-COUNTER	-(0 : Reset)	-	-	-	-	-	-	-	○	○
GAIN	0 ~ 18	-	-	-	-	-	○	○	-	○
GAIN-TAP1										
GAIN-TAP2										
GAIN-FINE										
GAIN-FINE-TAP1										
GAIN-FINE-TAP2										



Command	Parameter 1	Parameter 2	Parameter 3	Parameter 4	Camera	UserSet	SpecialTrigger	Load	UserSet	Reset	FactoryDefault
					Save				Reset		
GAIN-AUTO / AGC	0 / 1 / 2	-	-	-	-	○	-	○	-	○	○
GAIN-AUTO-LEVEL / AGC-LEVEL	0 ~ 11264 ~ 16383	-	-	-	-	○	-	○	-	○	○
GAIN-AUTO-SPEED / AGC-SPEED	1 ~ 256	-	-	-	-	○	-	○	-	○	○
GAIN-AUTO-UPPERLIMIT / AGC-UPPER	0 ~ 18	-	-	-	-	○	-	○	-	○	○
GAIN-AUTO-LOWERLIMIT / AGC-LOWER	0 ~ 18	-	-	-	-	○	-	○	-	○	○
GAIN-AUTO-FRAME-HIGHLIGHT / AGC-FRAME-HIGHLIGHT	0 / 1	-	-	-	-	-	-	-	-	○	○
GAIN-AUTO-FRAME / AGC-FRAME	1 ~ 50 ~ 100 : Width	1 ~ 50 ~ 100 : Height	0 ~ 25 ~ 99 : OffsetX	0 ~ 25 ~ 99 : OffsetY	-	○	-	○	-	○	○
GAIN-AUTO-WIDTH / AGC-WIDTH	1 ~ 50 ~ 100	-	-	-	-	○	-	○	-	○	○
GAIN-AUTO-HEIGHT / AGC-HEIGHT	1 ~ 50 ~ 100	-	-	-	-	○	-	○	-	○	○
GAIN-AUTO-OFFSETX / AGC-OFFSETX	0 ~ 25 ~ 99	-	-	-	-	○	-	○	-	○	○
GAIN-AUTO-OFFSETY / AGC-OFFSETY	0 ~ 25 ~ 99	-	-	-	-	○	-	○	-	○	○
GAIN-RED-FINE / RGAIN-FINE GAIN-RED-FINE-TAP1 / RGAIN-FINE-TAP1 GAIN-RED-FINE-TAP2 / RGAIN-FINE-TAP2	256 ~ *2 ~ 4095	-	-	-	-	-	-	○	○	-	○
GAIN-GREEN-FINE / GGAIN-FINE GAIN-GREEN-FINE-TAP1 / GGAIN-FINE-TAP1 GAIN-GREEN-FINE-TAP2 / GGAIN-FINE-TAP2	256 ~ *2 ~ 4095	-	-	-	-	-	-	○	○	-	○
GAIN-BLUE-FINE / BGA-FINE GAIN-BLUE-FINE-TAP1 / BGA-FINE-TAP1 GAIN-BLUE-FINE-TAP2 / BGA-FINE-TAP2	256 ~ *2 ~ 4095	-	-	-	-	-	-	○	○	-	○
WHITEBALANCE-AUTO / AWB	0 : Off 1 : On	-	-	-	-	-	-	-	-	○	○

Command	Parameter 1	Parameter 2	Parameter 3	Parameter 4	Camera	UserSet	SpecialTrigger	UserSet	Reset	FactoryDefault
					Save	Load	Reset	Reset		
WHITEBALANCE-FRAME-HIGHLIGHT / AWB-FRAME-HIGHLIGHT	0 : Off 1 : On	-	-	-	-	-	-	-	○	○
WHITEBALANCE-FRAME / AWB-FRAME	1 ~ 50 ~ 100 : Width	1 ~ 50 ~ 100 : Height	0 ~ 25 ~ 99 : OffsetX	0 ~ 25 ~ 99 : OffsetY	-	○	-	○	-	○
WHITEBALANCE-FRAME-WIDTH / AWB-WIDTH	1 ~ 50 ~ 100	-	-	-	-	○	-	○	-	○
WHITEBALANCE-FRAME-HEIGHT / AWB-HEIGHT	1 ~ 50 ~ 100	-	-	-	-	○	-	○	-	○
WHITEBALANCE-FRAME-OFFSETX / AWB-OFFSETX	0 ~ 25 ~ 99	-	-	-	-	○	-	○	-	○
WHITEBALANCE-FRAME-OFFSETY / AWB-OFFSETY	0 ~ 25 ~ 99	-	-	-	-	○	-	○	-	○
BLACKLEVEL / BL*1	~ 2047	-	-	-	-	○	○	○	-	○
BLACKLEVEL-ADJUST-TAP1 / BL-ADJ-1	-255 ~ 0 ~ +255	-	-	-	-	○	○	○	-	○
BLACKLEVEL-ADJUST-TAP2 / BL-ADJ-2										
BLACKLEVEL-AUTO-BALANCE / BL-AB	0 / 1 / 2	-	-	-	-	○	-	○	-	○
BLACKLEVEL-AUTO-BALANCE-LIMIT / BL-AB-LIMIT	1 ~ 512 ~ 16383	-	-	-	-	○	-	○	-	○
LUT-FORMAT	0 / 1 / 2 / 3 / 4	-	-	-	-	○	○	○	-	○
LINEAR-INTERPOLATION	1 ~ 5 : point	0 ~ 4095 : In Value	0 ~ 4095 : Out Value	-	○	-	-	-	-	○
LINEAR-INTERPOLATION-BUILD	-	-	-	-	-	-	-	-	-	-
LUT	0 ~ 4095 : Index	0 ~ 4095 : Value	-	-	○	-	-	-	-	○
LUT-SAVE	-	-	-	-	-	-	-	-	-	-
BINARIZATION	0 ~ 2047 ~ 4095	-	-	-	-	○	○	○	-	○
USERSET-LOAD	0 ~ 16	-	-	-	-	-	-	-	-	-
USERSET-SAVE	1 ~ 16	-	-	-	-	-	-	-	-	-
FACTORY-DEFAULT	-	-	-	-	-	-	-	-	-	-



Command	Parameter 1	Parameter 2	Parameter 3	Parameter 4	Camera	UserSet	SpecialTrigger	UserSet	Reset	FactoryDefault
					Save	Load	Reset	Reset		
USERSET-DEFAULT	0 ~ 16	-	-	-	-	-	-	-	-	-
USERSET-NAME	31 characters	-	-	-	-	○	○	○	-	○
USERSET-NAME-DELETE	-	-	-	-	-	-	-	-	-	-
USERSET-MEMORY	0 ~ 15 : Index	0 : Value	-	-	-	○	○	○	-	○
COLOR-TRANSFORMATION / CR-TF	0 / 1	-	-	-	-	○	○	○	-	○
COLOR-TRANSFORMATION-VALUE / CR-TF-VAL	00 / 01 / 02 / 10 / 11 / 12 / 20 / 21 / 22	-8191 ~ +8191	-	-	-	○	○	○	-	○
SHADING-CORRECTION	0 / 1	-	-	-	-	○	○	○	-	○
SHADING-DETECTION	0 / 1	-	-	-	-	-	-	-	-	-
SHADING-PATTERN-LOAD	0 / 1 / 2 / 3	-	-	-	-	○	○	○	-	○
SHADING-PATTERN-SAVE	0 / 1 / 2	-	-	-	-	-	-	-	-	-
DEFECT-CORRECTION	0 / 1	-	-	-	-	○	○	○	-	○
DEFECT-DETECTION	0 / 1 / 2	-	-	-	-	-	-	-	-	-
DEFECT-PATTERN-LOAD	0 / 1 / 2	-	-	-	-	○	○	○	-	○
DEFECT-PATTERN-SAVE	-	-	-	-	-	-	-	-	-	-
DEFECT-THRESHOLD	0 ~ 8192 ~ 16383	-	-	-	○	-	-	-	-	○
DEFECT-DETECTION-RESULT	-1 ~ 0 ~ 2047	-	-	-	-	-	-	-	-	-
FREE-MEMORY	0 ~ (32Kbyte / 4) : Index	0 : Value	-	-	○	-	-	-	-	○
FREE-MEMORY-READ	0 ~ 8191 : Index	1 ~ (8192 - Index) : Size	-	-	-	-	-	-	-	-
FREE-MEMORY-SAVE	-	-	-	-	-	-	-	-	-	-
VISIBILITY	1 / 2 / 3	-	-	-	-	-	-	-	-	○
HELP	-(Each command)	-	-	-	-	-	-	-	-	-

\*1 For the factory setting, refer to the Parameter List (page 47).

\*2 The factory setting differs for each camera.

# Parameter List

	XCL-C30/C	XCL-C32/C	XCL-C130/C	XCL-C280/C	XCL-C500/C
VSUB-EXTERNAL-MODE	0: Off 1: On	0: Off 1: On	0: Off	0: Off 1: On	1: On
VSUB-EXTERNAL	80	76	-	81	*1
SENSOR-TAP	1: 1 ch	1: 1 ch	1: 1 ch	1: 1 ch 2: 2 ch	2: 2 ch
ROI	Width	16 ~ 640 ~ 658	16 ~ 1280 ~ 1296	16 ~ 1920 ~ 1940	16 ~ 2448 ~ 2456
	Height	2 ~ 480 ~ 494	2 ~ 480 ~ 494	2 ~ 1440 ~ 1460	480 ~ 2048 ~ 2058
	OffsetX	0 ~ 8 ~ (658 - Width)	0 ~ 8 ~ (658 - Width)	0 ~ 10 ~ (1940 - Width)	0 ~ 4 ~ (2456 - Width)
OffsetY	0 ~ 6 ~ (494 - Height)	0 ~ 6 ~ (494 - Height)	0 ~ 2 ~ (966 - Height)	0 ~ 10 ~ (1460 - Height)	0 ~ 4 ~ (2058 - Height)
Width	16 ~ 640 ~ 658	16 ~ 640 ~ 658	16 ~ 1280 ~ 1296	16 ~ 1920 ~ 1940	16 ~ 2448 ~ 2456
Height	2 ~ 480 ~ 494	2 ~ 480 ~ 494	2 ~ 960 ~ 966	2 ~ 1440 ~ 1460	480 ~ 2048 ~ 2058
OffsetX	0 ~ 8 ~ (658 - Width)	0 ~ 8 ~ (658 - Width)	0 ~ 8 ~ (1296 - Width)	0 ~ 10 ~ (1940 - Width)	0 ~ 4 ~ (2456 - Width)
OffsetY	0 ~ 6 ~ (494 - Height)	0 ~ 6 ~ (494 - Height)	0 ~ 2 ~ (966 - Height)	0 ~ 10 ~ (1460 - Height)	0 ~ 4 ~ (2058 - Height)
FRAMERATE	62500 ~ 13000000 ~ *2	62500 ~ 10400000 ~ *2	62500 ~ 31000000 ~ *2	62500 ~ 26000000 ~ *2	62500 ~ 150000000 ~ *2
EXP	10 ~ 7674 ~ 2000000	10 ~ 9593 ~ 2000000	10 ~ 32169 ~ 2000000	10 ~ 37880 ~ 2000000	10 ~ 64825 ~ 2000000
AE-UPPER	10 ~ 7674 ~ 2000000	10 ~ 9593 ~ 2000000	10 ~ 32169 ~ 2000000	10 ~ 37880 ~ 2000000	10 ~ 64825 ~ 2000000
BLACKLEVEL	0 ~ 1023 ~ 2047	0 ~ 1023 ~ 2047	0 ~ 1023 ~ 2047	*1 ~ 960 ~ 2047	*1 ~ 960 ~ 2047

\*1 The factory setting differs for each camera.

\*2 The upper limit depends on the partial scan setting.

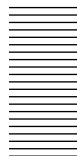

## Specifications

Pickup device	Progressive scan CCD XCL-C30/C30C/C130/C130C: 1/3 type XCL-C32/C32C: 1/2 type XCL-C280/C280C: 1/1.8 type XCL-C500/C500C: 2/3 type
Standard video output size (horizontal/vertical)	XCL-C30/C30C/C32/C32C: 640×480 XCL-C130/C130C: 1,280×960 XCL-C280/C280C: 1,920×1,440 XCL-C500/C500C: 2,448×2,048
Frame rate	XCL-C30/C30C: 130 fps XCL-C32/C32C: 104 fps XCL-C130/C130C: 31 fps XCL-C280/C280C: 26 fps XCL-C500/C500C: 15 fps
Lens mount	C-mount
Flange focal length	17.526 mm
Video output signal	XCL-C30/C32/C130/C280/C500: Mono 8 bits (default setting)/10 bits/ 12 bits XCL-C30C/C32C/C130C/C280C/ C500C: Raw 8 bits (default setting)/10 bits/ 12 bits, RGB 24 bits
Reference video output level	235 steps (8 bits)/3760 steps (12 bits)
Reference pedestal level	XCL-C30/C30C/C32/C32C/C130/ C130C: 16 steps (8 bits)/256 steps (12 bits) XCL-C280/C280C/C500/C500C: 15 steps (8 bits)/240 steps (12 bits)
Range of guarantee video output	XCL-C30/C30C/C32/C32C/C130/ C130C: 16 – 243 steps (8 bits)/256 – 3900 steps (12 bits) XCL-C280/C280C/C500/C500C: 15 – 243 steps (8 bits)/240 – 3900 steps (12 bits)
Range of color temperature for white balance (color camera only)	XCL-C30C/C32C/C130C/C280C/ C500C: 2,400 K ~ 9,000 K

Minimum illumination	XCL-C30: 1.5 lx (gain control at +18 dB, F1.4, shutter speed at 1/90 sec) XCL-C32: 1.0 lx (gain control at +18 dB, F1.4, shutter speed at 1/60 sec) XCL-C130/C280/C500: 0.5 lx (gain control at +18 dB, F1.4) XCL-C30C: 15 lx (gain control at +18 dB, F1.4, shutter speed at 1/90 sec) XCL-C32C/C130C: 12 lx (gain control at +18 dB, F1.4) (only when shutter speed at 1/60 sec for XCL-C32C) XCL-C280C: 10 lx (gain control at +18 dB, F1.4) XCL-C500C: 8 lx (gain control at +18 dB, F1.4)
Sensitivity	XCL-C30/C32/C130/C280: F5.6 (gain control at 0 dB, 400 lx) (only when shutter speed at 1/90 sec for XCL-C30, 1/60 sec for XCL-C32) XCL-C500: F8 (with gain control at 0 dB, 400 lx) XCL-C30C/C32C/C130C/C280C: F5.6 (gain control at 0 dB, 2,000 lx) (only when shutter speed at 1/90 sec for XCL-C30C, 1/60 sec for XCL-C32C) XCL-C500C: F8 (gain control at 0 dB, 2,000 lx)
Gain	0 dB ~ 18 dB, Auto gain
Shutter speed	1/100,000sec to 2sec, automatic shutter
Gamma	$\gamma=1$ (Changeable by LUT)
Binning	XCL-C30/C32/C130/C280/C500: 2×1, 1×2, 2×2 XCL-C30C/C32C/C130C/C280C/ C500C: Not included
External trigger pulse condition	pulse width: Between 10 $\mu$ s and 2s amplitude: DC 2 V - 24 V (DC IN connector)
External power	DC 12 V (10.5 V - 15 V: DC IN connector/10 V - 13 V: DIGITAL IF connector)
Power consumption (DC 12 V input)	XCL-C30/C30C/C32/C32C: 2.8 W XCL-C130/C130C: 2.4 W XCL-C280/C280C: 3.0 W XCL-C500/C500C: 3.2 W



Usable cable length (DIGITAL IF cable)  
 XCL-C30/C30C/C32/C32C/C130/  
 C130C:  
 1TAP output: 7 m/2TAP output:  
 14 m  
 XCL-C280/C280C/C500/C500C:  
 1TAP output: 5 m/2TAP output:  
 10 m

Performance guarantee temperature  
 0 °C to 40 °C (32 °F to 104 °F)  
 Operating temperature  
 -5 °C to +45 °C (23 °F to 113 °F)  
 Storage temperature  
 -30 °C to +60 °C (-22 °F to 140 °F)  
 Operating relative humidity  
 20% to 80% (no condensation)  
 Storage relative humidity  
 20% to 95% (no condensation)  
 MTBF About 7.9 years  
 Vibration resistance  
 10 G (20 Hz to 200 Hz)  
 Shock resistance 70 G  
 External dimension (w/h/d)  
 29 × 29 × 30 mm (1 3/16 × 1 3/16 ×  
 1 3/16 inches) (excluding protrusions)  
 Mass About 56 g (1.9 oz)  
 Accessories Lens mount cap (1)  
 Operating Instructions (1)

Design and specifications are subject to change without notice.

**IMPORTANT**  
 The nameplate is located on the bottom.

# Spectral Sensitivity Characteristics (Typical Values)

**XCL-C30**

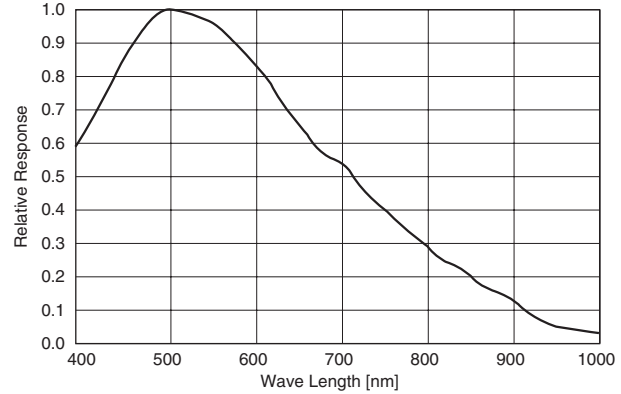

**XCL-C32**

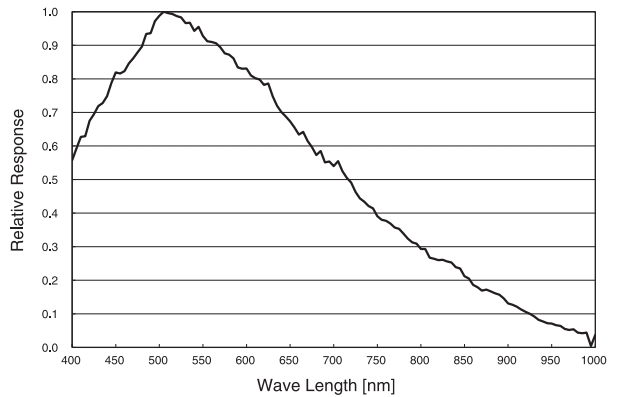

**XCL-C130**

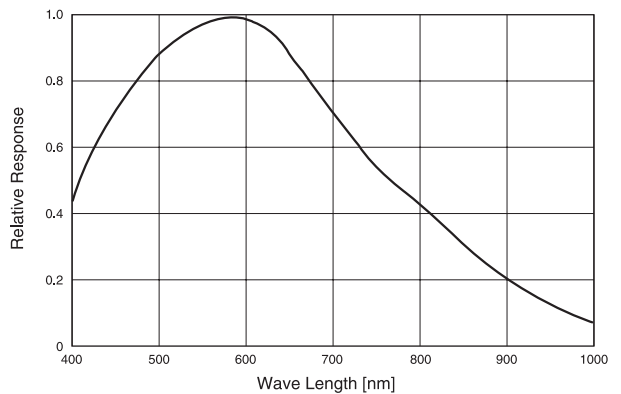

Specifications

### XCL-C280

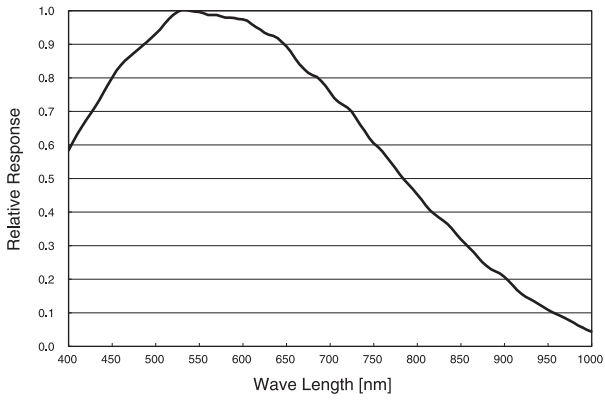

### XCL-C130C

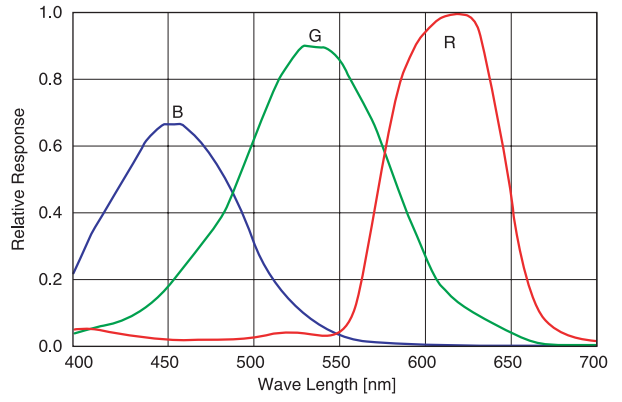

### XCL-C500

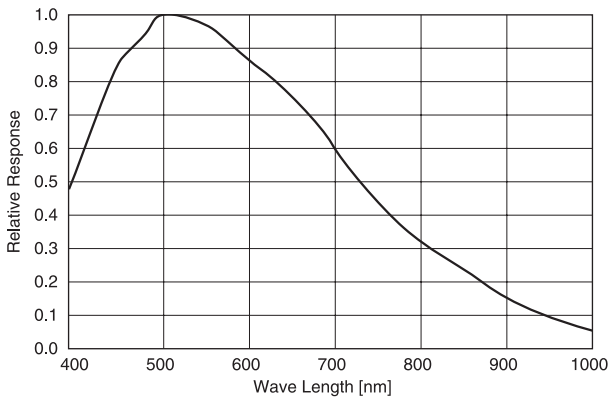

### XCL-C280C

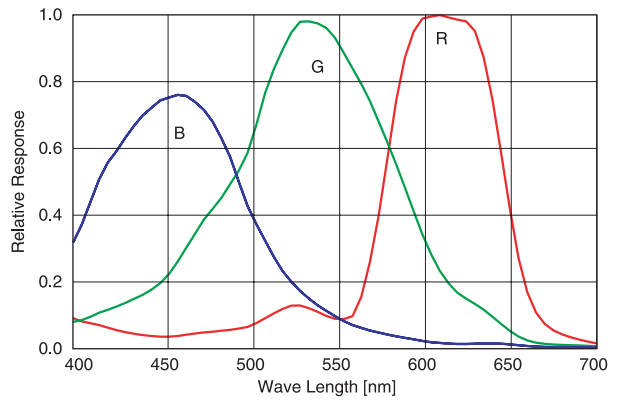

### XCL-C30C

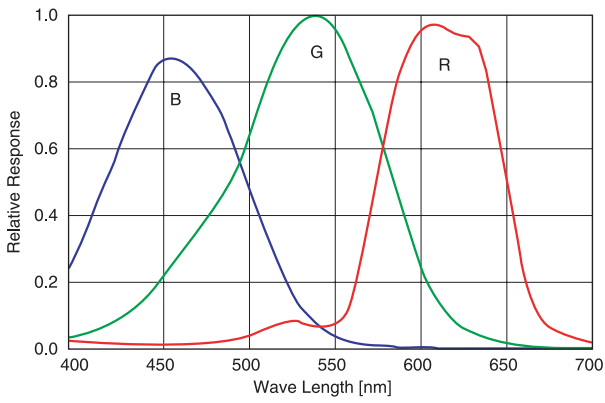

### XCL-C500C

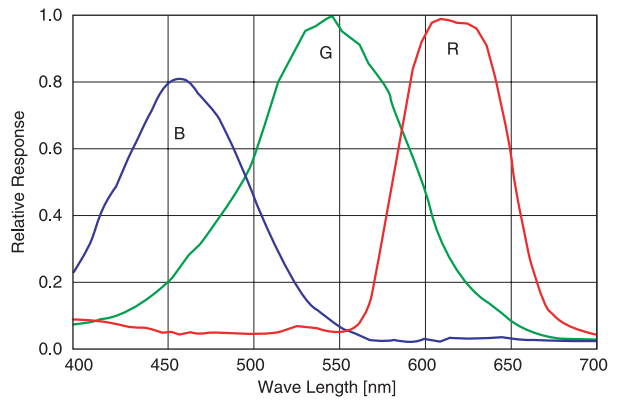

### XCL-C32C

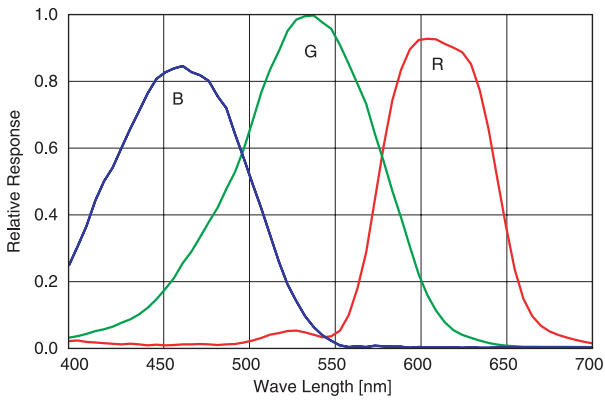

Specifications

# Dimensions

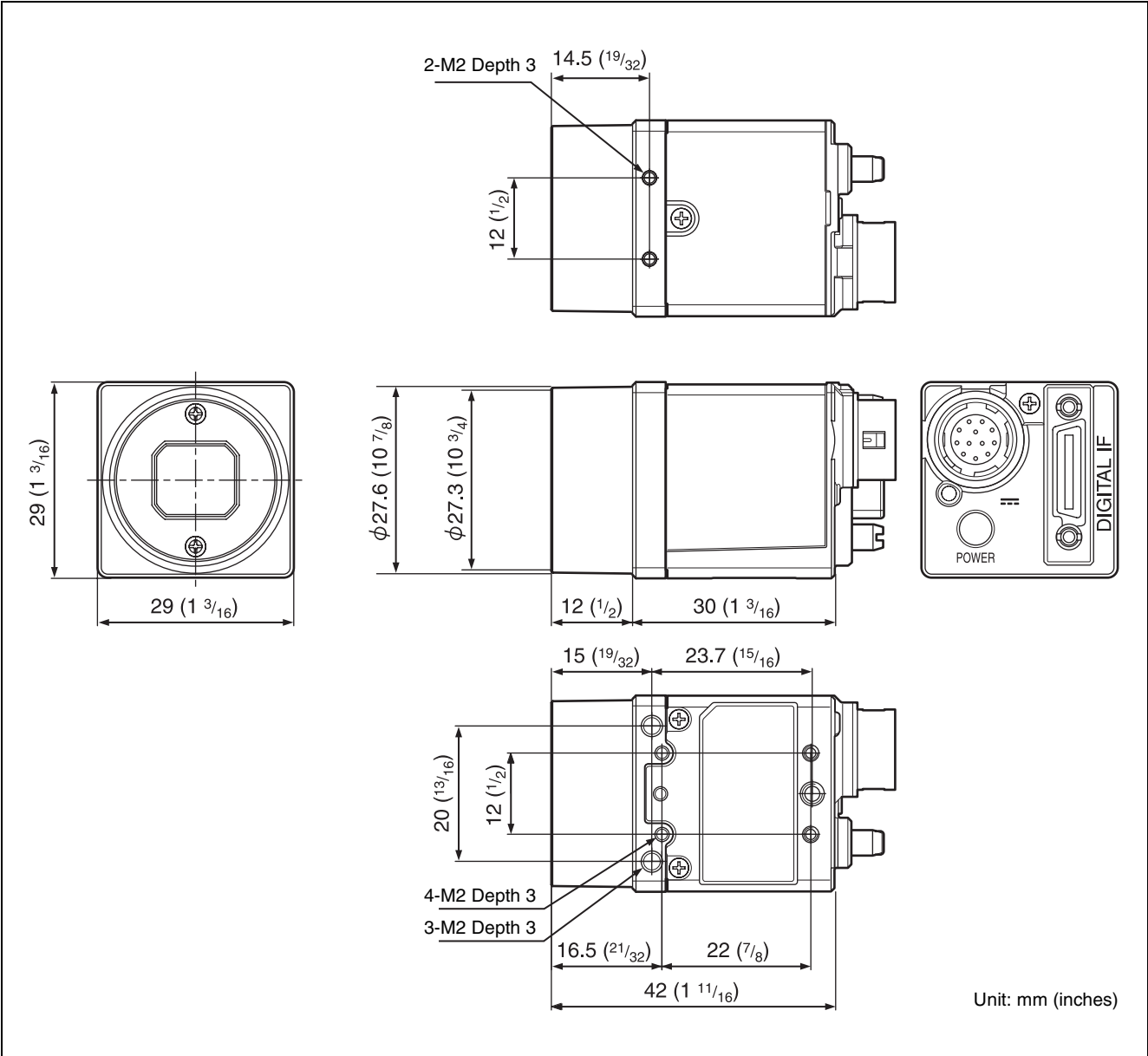

Specifications

Sony reserves the right to change specifications of the products and discontinue products without notice.  
Technical information contained herein is for reference only and does not convey any license by any implication or otherwise under any intellectual property right or other right of Sony or third parties.  
Sony cannot assume responsibility for any right infringements arising out of the use of this information.